

Production Cutting Tools

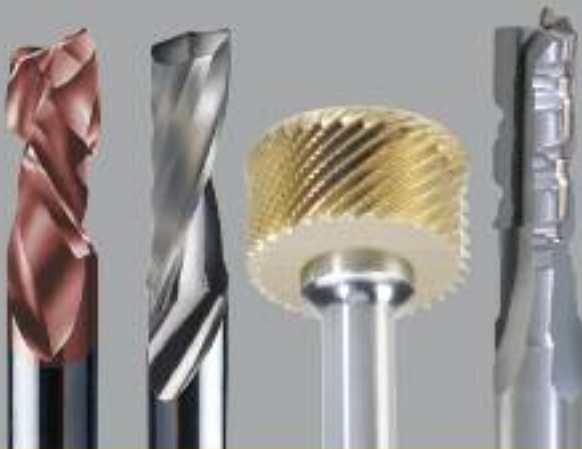



t h e
ONSRUD
a d v a n t a g e



Wood

Plastic

Honeycomb

Composite

comprehensive training

Increased productivity equals lower cost, improved profitability, and ultimately, survival of your business in today's competitive environment. **The LMT Onsrud Performance Team** will work with all levels of your operation to increase your productivity. All levels of training, general to production-specific on the shop floor, are only a call away!

factory technical support

LMT Onsrud provides your business with access to our staff of highly trained professional factory technicians. We can assist you with those difficult production machining problems while increasing your performance and productivity.

on-site trouble shooting

Correct tool selection, proper hold-down techniques, faster feed rates, fewer and quicker set ups are all pieces to the productivity puzzle. **The LMT Onsrud Performance Team** offers tailored solutions for problem solving and productivity gains.























custom tool design

Not only does LMT Onsrud offer the largest selection of cutting tools for day to day operations, but we will also design a tool for your specific application or material. We will take your tool requirements from the drawing board, to sophisticated computer-aided design, to in-house testing on our CNC router and CNC Mill. Custom tooling made to meet your productivity goals.





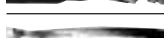

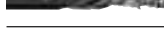





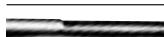

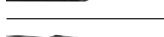



Table of Contents

Table of Contents	2 - 13	Resharpener Modifications	86
Cutting Tool Selection Guide & Technical Data	67-70	Quote Request Form	87
Chiploads	71-85	Custom Tool Design	88

Table of Contents by Material





SW SOFT WOOD Cedar, Cottonwood, Pine, Redwood	PAGE
 10-00 HSS 1F O Flute Straight	14
 28-50 CT 2F Flush Trim	17
 29-50 CT 2F Straight Chamfer	17
 37-50/60 Carbide 2F V Bottom	18
 37-80 CT 2F Lettering Bits	19
 42-00 CT 2F Straight Corner Round	20
 40-000 HSS 1F Upcut Spiral	26
 40-000 HSS 1F Downcut Spiral	26
 40-100 HSS 2F Upcut Spiral	27
 40-100 HSS 2F Downcut Spiral	27
 40-50 CT 2F Round & Rout	19
 52-200 SC 2F Spiral Upcut Wood Rout	29
 52-200B SC 2F Spiral Upcut Ball Nose	30
 52-400* SC 2F Spiral Upcut Wood Rout	30
 52-900 SC 2F Upcut Heavy Duty	32
 56-200 SC 2F Straight Wood Rout	33
 57-200 SC 2F Downcut Spiral Wood Rout	35
 57-200MD NEW SC Marathon Wood Rout Downcut	35
 57-400* SC 2F Downcut Spiral Wood Rout	36
 57-900 SC 2F Downcut Heavy Duty	36
 60-000 SC 3F High Helix Chipbreaker	37
 60-000 SC 3F Low Helix Chipbreaker	37

* Available In Metric

SW SOFT WOOD Cedar, Cottonwood, Pine, Redwood	PAGE
 60-090* SC 3F Upcut Lock Mortise	38
 60-100MC NEW SC Marathon Compression	38
 60-100 SC Compression Spiral	40
 60-100C SC 2F Chipbreaker/Finisher	39
 60-200 SC 3F Low Helix Finisher	41
 60-600 SC 4F High Velocity Compression Spiral	42
 60-700 SC 4F High Velocity Upcut Spiral	42
 60-700 SC 4F High Velocity Downcut Spiral	42
 60-800 SC 2F Roughers	43
 60-900 SC 3F Heavy Duty Hogger	43
 60-950 SC 2F Heavy Duty Chipbreaker/Finisher	43
 61-000 SC 1F "O" Flute Straight	44
 61-200 SC 1F Straight Wood Rout	45
 63-200 SC 1F Upcut Spiral Wood Rout	47
 64-000* SC 1F Downcut Super O	50
 65-000* SC 1F Upcut Super O	51
 72-000* SC Boring Bits	63
 77-100 SC 2F & 3F Taper Tools	64

* Available In Metric











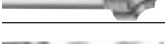





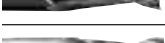

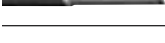

Table of Contents by Material

HW	HARD WOOD Ash, Beech, Birch, Cherry, Mahogany, Maple, Oak, Poplar, Teak, Walnut	PAGE	HW	HARD WOOD Ash, Beech, Birch, Cherry, Mahogany, Maple, Oak, Poplar, Teak, Walnut	PAGE
	12-00 HSS 2F V Flute Straight	14		60-090* SC 3F Upcut Lock Mortise	38
	28-50 CT 2F Flush Trim	17		60-100 SC Compression Spiral	40
	29-50 CT 2F Straight Chamfer	17		60-100MC NEW SC Marathon Compression	38
	37-50/60 Carbide 2F V Bottom	18		60-100C SC 2F Chipbreaker/Finisher	39
	37-80 CT 2F Lettering Bits	19		60-200 SC 3F Low Helix Finisher	41
	42-00 CT 2F Straight Corner Round	20		60-300 SC 2F Chipbreaker Finisher	41
	40-000 HSS 1F Upcut Spiral	26		60-350 SC 3F Chipbreaker Finisher	42
	40-000 HSS 1F Downcut Spiral	26		60-600 SC 4F High Velocity Compression Spiral	42
	40-100 HSS 2F Upcut Spiral	27		60-700 SC 4F High Velocity Upcut Spiral	42
	40-100 HSS 2F Downcut Spiral	27		60-700 SC 4F High Velocity Downcut Spiral	42
	40-50 CT 2F Round & Rout	19		60-800 SC 2F Roughers	43
	48-000 CT 1F & 2F Straight	28		60-900 SC 3F Heavy Duty Hogger	43
	52-200 SC 2F Spiral Upcut Wood Rout	29		60-950 SC 2F Heavy Duty Chipbreaker/Finisher	43
	52-200B SC 2F Spiral Upcut Ball Nose	30		61-200 SC 1F Straight Wood Rout	45
	52-400* SC 2F Spiral Upcut Wood Rout	30		63-200 SC 1F Upcut Spiral Wood Rout	47
	52-900 SC 2F Upcut Heavy Duty	32		64-000* SC 1F Downcut Super O	50
	56-200 SC 2F Straight Wood Rout	33		65-000* SC 1F Upcut Super O	51
	57-200 SC 2F Downcut Spiral Wood Rout	35		72-000* SC Boring Bits	63
	57-200MD NEW SC Marathon Wood Rout Downcut	35		77-100 SC 2F & 3F Taper Tools	64
	57-400* SC 2F Downcut Spiral Wood Rout	36			
	57-900 SC 2F Downcut Heavy Duty	36			
	60-000 SC 3F High Helix Chipbreaker	37			
	60-000 SC 3F Low Helix Chipbreaker	37			













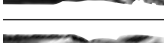

* Available In Metric

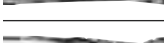
* Available In Metric

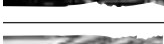
Table of Contents by Material

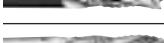

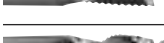











CW MDF	PAGE
 28-50 CT 2F Flush Trim	17
 29-50 CT 2F Straight Chamfer	17
 37-50/60 Carbide 2F V Bottom	18
 37-80 CT 2F Lettering Bits	19
 40-50 CT 2F Round & Rout	19
 42-00 CT 2F Straight Corner Round	20
 47-00 CT 2F MDF Panel Tools	20
 48-000 CT 1F & 2F Straight	28
 52-200 SC 2F Spiral Upcut Wood Rout	29
 52-200B SC 2F Spiral Upcut Ball Nose	30
 52-400* SC 2F Spiral Upcut Wood Rout	30
 52-900 SC 2F Upcut Heavy Duty	32
 56-200 SC 2F Straight Wood Rout	33
 57-200 SC 2F Downcut Spiral Wood Rout	35
 57-200MD NEW SC Marathon Wood Rout Downcut	35
 57-400* SC 2F Downcut Spiral Wood Rout	36
 57-900 SC 2F Downcut Heavy Duty	36
 60-000 SC 3F High Helix Chipbreaker	37
 60-000 SC 3F Low Helix Chipbreaker	37
 60-090* SC 3F Upcut Lock Mortise	38
 60-100 SC Compression Spiral	40

* Available In Metric

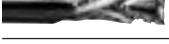



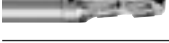





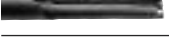

CW MDF	PAGE
 60-100MC NEW SC Marathon Compression	38
 60-100MW SC Max Life Compression Spiral	39
 60-100C SC 2F Chipbreaker/Finisher	39
 60-100DC SC Tuff Core Compression	39
 60-200 SC 3F Low Helix Finisher	41
 60-300 SC 2F Chipbreaker Finisher	41
 60-350 SC 3F Chipbreaker Finisher	42
 60-600 SC 4F High Velocity Compression Spiral	42
 60-700 SC 4F High Velocity Upcut Spiral	42
 60-700 SC 4F High Velocity Downcut Spiral	42
 60-800 SC 2F Roughers	43
 60-900 SC 3F Heavy Duty Hogger	43
 60-950 SC 2F Heavy Duty Chipbreaker/Finisher	43
 61-200 SC 1F Straight Wood Rout	45
 64-000* SC 1F Downcut Super O	50
 65-000* SC 1F Upcut Super O	51
 68-100 PCD 1F Compression	58
 72-000* SC Boring Bits	63
 77-100 SC 2F & 3F Taper Tools	64

* Available In Metric

Table of Contents by Material

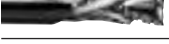













LW	LAMINATED CHIPBOARD	PAGE
	27-00 SC 1F Laminate Trim	16
	27-50 SC 2F Straight Laminate Trim	16
	28-50 CT 2F Flush Trim	17
	37-80 CT 2F Lettering Bits	19
	48-000 CT 1F Straight	28
	57-200MD NEW SC Marathon Wood Rout Downcut	35
	60-100 SC Compression Spiral	40
	60-100MW SC Max Life Compression Spiral	39
	60-100C SC 1F Chipbreaker/Finisher	39
	60-100DC SC Tuff Core Compression	39
	60-100MC NEW SC Marathon Compression	38
	60-600 SC 4F High Velocity Compression Spiral	42
	68-100 PCD 1F Compression	58
	72-000* SC Boring Bits	63
	77-100 SC 1F & 2F Taper Tools	64

* Available In Metric









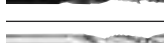
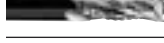

LW	LAMINATED PLYWOOD	PAGE
	27-00 SC 1F Laminate Trim	16
	27-50 SC 2F Straight Laminate Trim	16
	28-50 CT 2F Flush Trim	17
	37-80 CT 2F Lettering Bits	19
	48-000 CT 1F Straight	28
	57-200MD SC Marathon Wood Rout Downcut	35
	60-100 SC Compression Spiral	40
	60-100MC NEW SC Marathon Compression	38
	60-100C SC 2F Chipbreaker/Finisher	39
	60-600 SC 4F High Velocity Compression Spiral	42
	68-100 PCD 1F Compression	58
	72-000* SC Boring Bits	63
	77-100 SC 2F & 3F Taper Tools	64

* Available In Metric

Table of Contents by Material

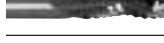

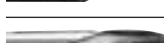
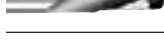











CW	SOFT PLYWOOD	PAGE
	37-50/60 SC 2F V Bottom	18
	37-80 CT 2F Lettering Bits	19
	40-50 CT 2F Round & Rout	19
	48-000 CT 1F & 2F Straight	28
	56-200 SC 2F Straight Wood Rout	33
	57-200MD NEW SC Marathon Wood Rout Downcut	35
	60-000 SC 3F High Helix Chipbreaker	37
	60-000 SC 3F Low Helix Chipbreaker	37
	60-090* SC 3F Upcut Lock Mortise	38
	60-100MC NEW SC Marathon Compression	38
	60-100 SC Compression Spiral	40
	60-100C SC 2F Chipbreaker/Finisher	39
	60-100DC SC Tuff Core Compression	39
	60-300 SC 2F Chipbreaker Finisher	41

* Available In Metric













CW	SOFT PLYWOOD	PAGE
	60-350 SC 3F Chipbreaker Finisher	42
	60-600 SC 4F High Velocity Compression Spiral	42
	60-700 SC 4F High Velocity Upcut Spiral	42
	60-700 SC 4F High Velocity Downcut Spiral	42
	60-800 SC 2F Roughers	43
	60-900 SC 3F Heavy Duty Hogger	43
	60-950 SC 2F Heavy Duty Chipbreaker/Finisher	43
	61-200 SC 1F Straight Wood Rout	45
	64-000* SC 1F Downcut Super O	50
	65-000* SC 1F Upcut Super O	51
	68-100 PCD 1F Compression	58
	72-000* SC Boring Bits	63
	77-100 SC 2F & 3F Taper Tools	64

* Available In Metric

Table of Contents by Material

CW	HARD PLYWOOD	PAGE
	37-50/60 Carbide 2F V Bottom	18
	37-80 CT 2F Lettering Bits	19
	40-50 CT 2F Round & Rout	19
	48-000 CT 1F & 2F Straight	28
	56-200 SC 2F Straight Wood Rout	33
	57-200MD NEW SC Marathon Wood Rout Downcut	35
	60-000 SC 3F High Helix Chipbreaker	37
	60-000 SC 3F Low Helix Chipbreaker	37
	60-090* SC 3F Upcut Lock Mortise	38
	60-100 SC Compression Spiral	40
	60-100MC NEW SC Marathon Compression	38
	60-100C SC 2F Chipbreaker/Finisher	39
	60-100DC SC Tuff Core Compression	39
	60-300 SC 2F Chipbreaker Finisher	41

* Available In Metric

CW	HARD PLYWOOD	PAGE
	60-350 SC 3F Chipbreaker Finisher	42
	60-600 SC 4F High Velocity Compression Spiral	42
	60-700 SC 4F High Velocity Upcut Spiral	42
	60-700 SC 4F High Velocity Downcut Spiral	42
	60-800 SC 2F Roughers	43
	60-900 SC 3F Heavy Duty Hogger	43
	60-950 SC 2F Heavy Duty Chipbreaker/Finisher	43
	61-200 SC 1F Straight Wood Rout	45
	64-000* SC 1F Downcut Super O	50
	65-000* SC 1F Upcut Super O	51
	68-100 PCD 1F Compression	58
	72-000* SC Boring Bits	63
	77-100 SC 2F & 3F Taper Tools	64

















* Available In Metric

Table of Contents by Material

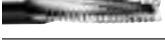
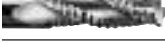

SOFT PLASTIC

ABS, Polycarbonate, Polyethylene, PVC,
Polypropylene, HDPE, Polystyrene, UHMW,
Extruded Acrylic

















		PAGE
	10-00 HSS 1F O Flute Straight	14
	11-00 HSS 1F or 2F O Flute Straight	14
	28-20 SC Double Bearing Plastic Trim	17
	28-50 CT 2F Flush Trim	17
	37-50/60 Carbide 2F V Bottom	18
	40-50 CT 2F Round & Rout	19
	52-200 SC 2F Spiral Upcut Wood Rout	29
	52-200B/BL SC 2F Ball Nose	30
	52-400* SC 2F Spiral Upcut Wood Rout	30
	52-600 SC 2F Upcut "O" Flute	31
	52-700* SC 2F Upcut "O" Flute	31
	56-430* SC 2F Straight O Flute	34
	56-600 SC 2F Straight "O" Flute	34
	57-600* SC 2F Downcut "O" Flute	36
	60-000 SC 3F High Helix Chipbreaker	37
	60-000 SC 3F Low Helix Chipbreaker	37
	60-900 SC 3F Heavy Duty Hogger	43
	61-000P SC 1F "O" Flute Straight	44

* Available In Metric





















SOFT PLASTIC

ABS, Polycarbonat, Polyethylene, PVC,
Polypropylene, HDPE, Polystyrene, UHMW,
Extruded Acrylic

















		PAGE
	61-400* SC 1F Straight	45
	62-750 SC 1F Downcut "O" Flute	46
	62-850* SC 1F Downcut "O" Flute	46
	63-500 SC 1F Upcut "O" Flute	48
	63-750 SC 1F Upcut "O" Flute	49
	63-850* SC 1F Upcut "O" Flute	49
	64-000* SC 1F Downcut Super O	50
	65-000* SC 1F Upcut Super O	51
	65-200B* NEW SC 2F High Finish Ballnose for Plastics	51
	65-300B NEW SC 4F High Finish Ballnose for Plastics	51
	66-000 SC Edge Rounding Bits	52
	66-200 SC 2F Rout and Chamfer	53
	66-300 SC 2F Upcut Bottom Surfacing	53
	67-200 SC 3F Phenolic/Composite Cutter	55
	67-800* SC 8 Facet Drill	57
	70-500* HSS Plastic Drills	62
	77-100 SC 2F & 3F Taper Tools	64

* Available In Metric

Table of Contents by Material



























HP HARD PLASTIC Cast Acrylic, Melamine, Nylon, PVC, Vinyl	<i>PAGE</i>
 11-00 HSS 1F or 2F O Flute Straight	14
 28-20 SC Double Bearing Plastic Trim	17
 37-50/60 Carbide 2F V Bottom	18
 40-50 CT 2F Round & Rout	19
 52-200B/BL SC 2F Ball Nose	30
 52-600 SC 2F Upcut "O" Flute	31
 56-000 SC 2F Straight	33
 56-000P SC 2F Straight	33
 56-430* SC 2F Straight O Flute	34
 56-450* SC 2F Straight	34
 56-600 SC 2F Straight "O" Flute	34
 57-600* SC 2F Downcut "O" Flute	36
 60-000 SC 3F High Helix Chipbreaker	37
 60-000 SC 3F Low Helix Chipbreaker	37
 60-200 SC 3F Low Helix Finisher	41
 60-900 SC 3F Heavy Duty Hogger	43
 61-000P SC 1F "O" Flute Straight	44
 61-400* SC 1F Straight	45

* Available In Metric

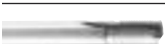









HP HARD PLASTIC Cast Acrylic, Melamine, Nylon, PVC, Vinyl	<i>PAGE</i>
 62-700 SC 1F Downcut "O" Flute	46
 62-750 SC 1F Downcut "O" Flute	46
 62-800* SC 1F Downcut "O" Flute	46
 62-850* SC 1F Downcut "O" Flute	46
 63-500 SC 1F Upcut "O" Flute	48
 63-700 SC 1F Upcut "O" Flute	49
 63-750 SC 1F Upcut "O" Flute	49
 63-800* SC 1F Upcut "O" Flute	49
 63-850* SC 1F Upcut "O" Flute	49
 64-000* SC 1F Downcut Super O	50
 65-000* SC 1F Upcut Super O	51
 66-000 SC Edge Rounding Bits	52
 66-200 SC 2F Rout and Chamfer	53
 66-300 SC 2F Upcut Bottom Surfacing	53
 70-500* HSS Plastic Drills	62
 77-100 SC 2F & 3F Taper Tools	64

* Available In Metric









Table of Contents by Material

CP	COMPOSITE Fiberglass, Phenolic, Reinforced Acetal	PAGE
	48-000 CT 1F & 2F Straight	28
	52-000 SC 2F Spiral Upcut	29
	53-000 SC 3F Straight	32
	54-200* NEW SC 3F & 4F Spiral for Glass Reinforced Plastic	32
	56-000 SC 2F Straight	33
	56-000P SC 2F Straight	33
	56-450* SC 2F Straight	34
	57-000 SC 2F Downcut Spiral	35
	63-000 SC 1F Upcut Spiral	46
	66-800* NEW DFC Compression for Composites	53
	66-900* NEW SC High Performance Composite Router	54
	67-000 SC Fiberglass Burr Bits	55
	67-200 SC 3F Phenolic/Composite Cutter	55
	67-220 NEW PCD 3F Progressive Chipbreaker	56
	67-250 3F Diamond Grit Tools	55
	67-300 SC 2F Compression Spiral	56
	67-400* SC Un-Ruffer	56
	67-500 SC Carbon Graphite Tool	56
	67-800* SC 8 Facet Drill	57
	68-000 2F PCD Tipped Tools	58
	68-200* PCD 2F SERF	59
	68-300* NEW PCD 3F SERF™ Cutter	59
	68-400* NEW PCD Ballnose	59
	68-900 PCD 8 Facet Drills	60
	85-800* NEW SC CFRP Drills	66
	86-100 SC DFC Parabolic Drill	67

* Available In Metric

























HONEYCOMB	PAGE	
	29-000 HSS Hollow Core Cutters	21
	29-050 Diamond Grit Hogger	21
	29-100/29-100B* SC Honeycomb Hogger	22
	30-000 Replaceable Ring Type Honeycomb Cutter	22
	30-300 HSS Integral Shank Honeycomb Hogger Cutter	23
	30-700 Reduced Weight Honeycomb Cutter	23
	31-000 HSS Cutter	24
	31-100 HSS Honeycomb Cutter with Teeth	24
	32-000 HSS Hogger	25
	32-200 NEW HSS 3 Piece Honeycomb Hogger	25
	34-000 Aircraft Panel Tools	26

* Available In Metric

SPECIAL PURPOSE	PAGE	
	37-00* SC 1F 60° Engraving Tools	18
	37-20* SC 1F 30° Engraving Tools	18
	37-70 CT 2F Dibond/Alucobond Folding Tool	19
	70-100 CT Blade and Arbor	60
	70-200 SC Flush Mount Blade	61
	70-300 CT Flush Mount Blade	61
	83-300 SC 2F Upcut	65
	91-000 CT Spoilboard Cutter	67
	91-100 Insert Spoilboard Cutter	67



















* Available In Metric

Table of Contents by Material

SSP	SOLID SURFACE	PAGE	SSP	SOLID SURFACE	PAGE
	37-50/60 Carbide 2F V Bottom	18		60-200 SC 3F Low Helix Finisher	41
	40-50 CT 2F Round & Rout	19		62-700 SC 1F Downcut "O" Flute	46
	42-00 CT 2F Straight Corner Round	20		62-750 SC 1F Downcut "O" Flute	46
	52-000 SC 2F Spiral Upcut	29		62-800* SC 1F Downcut "O" Flute	46
	52-200 SC 2F Spiral Upcut Wood Rout	29		62-850* SC 1F Downcut "O" Flute	46
	52-200B/BL SC 2F Ball Nose	30		63-700 SC 1F Upcut "O" Flute	49
	52-400* SC 2F Spiral Upcut Wood Rout	30		63-750 SC 1F Upcut "O" Flute	49
	52-600 SC 2F Upcut "O" Flute	31		63-800* SC 1F Upcut "O" Flute	49
	52-700* SC 2F Upcut "O" Flute	31		63-850* SC 1F Upcut "O" Flute	49
	56-000P SC 2F Straight	33		64-000* SC 1F Downcut Super O	50
	56-450* SC 2F Straight	34		65-000* SC 1F Upcut Super O	51
	57-600 SC 2F Downcut "O" Flute	36		66-000 SC Edge Rounding Bits	52

* Available In Metric



* Available In Metric

A	ALUMINUM	PAGE	A	ALUMINUM	PAGE
	40-000 HSS 1F Upcut & Downcut Spiral	26		63-600 SC 1F "O" Flute Upcut Spiral	48
	40-100 HSS 2F Upcut & Downcut Spiral	27		63-900* SC 1F "O" Flute Upcut Spiral	50
	49-000 HSS 2F Steel Downcut	29		64-000* SC 1F Downcut Super O	50
	52-000 SC 2F Spiral Upcut	29		65-000* SC 1F Upcut Super O	51
	52-000B/BL SC 2F Ball Nose	30		66-300 SC 2F Upcut Bottom Surfacing	53
	57-000 SC 2F Downcut Spiral	35		77-100 SC 2F & 3F Taper Tools	64
	61-000 SC 1F "O" Flute Straight	44		80-000 HSS 3F Taper Pin Router	64
	62-600 SC 1F "O" Flute Downcut Spiral	45		81-000 HSS 2F Lo Helix	65
	63-000 SC 1F Upcut Spiral	46		81-100 SC 2F Extrusion Cutter	65
	63-400* NEW SC 1F Upcut for Soft Aluminum	47			





* Available In Metric

* Available In Metric

Table of Contents by Material

CM DW	CONSTRUCTION MATERIAL Drywall, RV/Mobile and Modular Housing	<i>PAGE</i>
	18-00 HSS 1F Straight Pilot Bit	15
	20-00 HSS 1F Downcut Spiral Pilot Bit	16



* Available In Metric

FP	FOAM	<i>PAGE</i>
	12-00 HSS 2F V Flute Straight	14
	52-700* SC 2F Upcut "O" Flute	31
	56-000P SC 2F Straight	33
	48-000 CT 1F & 2F Straight	28

* Available In Metric

MT	MORTISING	<i>PAGE</i>
	60-100 SC Mortise Compression Spiral	40



* Available In Metric

D	METAL DOORS	<i>PAGE</i>
	15-50 HSS 1F Dor Bit	15
	15-75 HSS 3F Dor Bit	15

* Available In Metric

CM DW	CONSTRUCTION MATERIAL Drywall, RV/Mobile and Modular Housing	<i>PAGE</i>
	20-10 HSS 1F Drywall Bit	16

* Available In Metric

FP	FOAM	<i>PAGE</i>
	40-550 HSS 4F Foam Cutters	27
	52-550 SC 2F Foam Cutters	30
	77-100 SC 2F & 3F Taper Tools	64

* Available In Metric

MT	MORTISING	<i>PAGE</i>
	60-090 SC 3F Upcut Lock Mortise	38

* Available In Metric

M	METAL	<i>PAGE</i>
	83-300 SC 2F Stainless Steel Cutter	65

* Available In Metric

TABLE OF CONTENTS

10-00	HSS 1F O Flute Straight	14	52-600	SC 2F Upcut "O" Flute	31	63-500	SC 1F Acrylic Tools	48
11-00	HSS O Flute Straight	14	52-700*	SC 2F Upcut "O" Flute	31	63-600	SC 1F "O" Flute Upcut Spiral	48
12-00	HSS 2F V Flute Straight	14	52-900	SC 2F Upcut Heavy Duty	32	63-700	SC 1F Upcut "O" Flute	49
15-50	HSS 1F Steel Dor Bit	15	53-000	SC 3F Straight	32	63-750	SC 1F Upcut "O" Flute	49
15-75	HSS 3F CNC Dor Bit	15	54-200	SC 3F & 4F Spiral for Glass Reinforced Plastic	32	63-800*	SC 1F Upcut "O" Flute	49
18-00	HSS 1F Straight Pilot	15	56-000	SC 2F Straight	33	63-850*	SC 1F Upcut "O" Flute	49
20-00	HSS 1F Downcut Spiral Pilot	16	56-000P	SC 2F Straight	33	63-900*	SC 1F "O" Flute Upcut Spiral	50
20-10	HSS 1F Drywall Bit	16	56-200	SC 2F Straight Wood Rout	33	64-000*	SC 1F Downcut Super O	50
27-00	SC 1F Laminate Trim	16	56-200	SC 2F Straight Wood Rout	33	65-000*	SC 1F Upcut Super O	51
27-50	SC 2F Laminate Trim	16	56-430*	SC 2F Straight O Flute	34	65-200B*	SC 2F High Finish Ballnose	51
28-20	SC Double-Bearing Plastic Trim	17	56-450*	SC 2F Straight	34	65-300B*	SC 4F High Finish Ballnose	51
28-50	CT Flush Trim	17	56-600	SC 2F Straight "O" Flute	34	66-000	SC Edge Rounding Bits	52
29-50	CT Chamfer	17	57-000	SC 2F Downcut Spiral	35	66-200	SC 2F Rout and Chamfer	53
37-00*	SC 1F 60° Engraving Tools	18	57-200	SC 2F Downcut Spiral Wood Rout	35	66-300	SC 2F Upcut Bottom Surfacing	53
37-20*	SC 1F 30° Engraving Tools	18	57-200MD	SC Marathon Wood Rout Downcut	35	66-800*	DFC Compression for Composites	53
37-50/60	Carbide 2F V Bottom	18	57-400*	SC 2F Downcut Spiral Wood Rout	36	66-900*	SC High Performance Composite Router	54
37-70	CT 2F Dibond/Alucobond Folding Tool	19	57-600*	SC 2F Downcut "O" Flute	36	67-000	SC Fiberglass Burr Bits	55
37-80	CT 2F Lettering Bits	19	57-900	SC 2F Downcut Heavy Duty	36	67-250	3F Diamond Grit Tools	55
40-50	CT 2F Round & Rout	19	60-000	SC 3F High Helix Chipbreaker	37	67-200*	SC 3F Phenolic/Composite Cutter	55
42-00	CT 2F Corner Round	20	60-000	SC 3F Low Helix Chipbreaker	37	67-220	PCD 3F Phenolic/ Composite Cutter	56
47-00	CT 2F MDF Panel Bits	20	60-090*	SC 3F Upcut Lock Mortise	38	67-300	SC 2F Compression Spiral	56
90-00	T Slot	20	60-100	SC Compression Spiral	40	67-400*	SC Un-Ruffer	56
29-000	HSS Hollow Core Cutters	21	60-100C	SC 2F Chipbreaker/Finisher	39	67-500	SC Carbon Graphite Tool	56
29-050	Diamond Grit Hogger	21	60-100MC	SC Marathon Compression	38	67-800*	SC 8 Facet Drills	57
29-100/	SC Honeycomb Hogger	22	60-100MW	SC Max Life Compression Spiral	39	68-000	2F PCD Tipped Tools	58
29-100B			60-100DC	SC Tuff Core Compression	39	68-100	PCD 1F Compression	58
30-000	Replaceable Ring Type Honeycomb Cutter	22	60-200	SC 3F Low Helix Finisher	41	68-200*	PCD 2F SERF	59
30-300	HSS Integral Shank Honeycomb Hogger Cutter	23	60-300	SC 2F Chipbreaker Finisher	41	68-300*	PCD 3F SERF™ Cutter	59
30-700	Reduced Weight Honeycomb Cutter	23	60-350	SC 3F Chipbreaker Finisher	42	68-400*	PCD Ballnose	59
31-000	HSS Cutter	24	60-600	SC 4F High Velocity Compression Spiral	42	68-900	PCD 8 Facet Drills	60
31-100	HSS Honeycomb Cutter with Teeth	24	60-700	SC 4F High Velocity Upcut Spiral	42	70-100	CT Blade and Arbor	60
32-000	HSS Hogger	25	60-700	SC 4F High Velocity Dwncut Spiral	42	70-200	SC Flush Mount Blade	61
32-200	HSS 3 Piece Honeycomb Hogger	25	60-800	SC 2F Roughers	43	70-300	CT Flush Mount Blade	61
34-000	Aircraft Panel Tools	26	60-900	SC 3F Heavy Duty Hogger	43	70-500*	HSS Plastic Drill	62
40-000	HSS 1F Upcut Spiral	26	60-950	SC 2F Heavy Duty Chipbreaker/Finisher	43	72-000*	SC Boring Bits	63
40-000	HSS 1F Downcut Spiral	26	61-000	SC 1F "O" Flute Straight	44	77-100*	SC 2F & 3F Taper Tools	64
40-100	HSS 2F Upcut Spiral	27	61-000P	SC 1F "O" Flute Straight	44	80-000	HSS 3F Taper Pin Router	64
40-100	HSS 2F Downcut Spiral	27	61-200	SC 1F Straight Wood Rout	45	81-000	HSS 2F Lo Helix	65
40-550	HSS 4F Foam Cutters	27	61-400*	SC 1F Straight	45	81-100	SC 2F Extrusion Cutter	65
48-000	CT 1F Straight	28	62-600	SC 1F "O" Flute Downcut Spiral	45	83-300	Stainless Steel Tools	65
48-000	CT 2F Straight	28	62-700	SC 1F Downcut "O" Flute	46	85-800*	SC CFRP Drills	66
49-000	HSS 2F Steel Downcut	29	62-750	SC 1F Downcut "O" Flute	46	86-100	SC DFC Parabolic Drills	67
52-000	SC 2F Spiral Upcut	29	62-800*	SC 1F Downcut "O" Flute	46	91-000	CT Spoilboard Cutter	67
52-200	SC 2F Spiral Upcut Wood Rout	29	62-850*	SC 1F Downcut "O" Flute	46	91-100	Insert Spoilboard Cutter	67
52-200B/BL*	SC 2F Ball Nose	30	63-000	SC 1F Upcut Spiral	46			
52-400*	SC 2F Spiral Upcut Wood Rout	30	63-200	SC 1F Upcut Spiral Wood Rout	47			
52-550	SC 2F Foam Cutters	30	63-400*	SC 1F Upcut for Soft Aluminum	47			

* Available in Metric

Single Flute - High Speed Steel O Flute Straight

Combines an open flute design with single flute geometry to provide optimum chip removal at fast feed rates. Excellent for hand-fed operations.

Usage ABS, polycarbonate, polyethylene, PVC, polypropylene, polystyrene, extruded acrylic, HDPE, UHMW, and natural wood

Material **SW** **SP** See Selection Guide - pg. 2 - 12

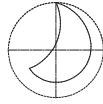

Part Number	Cutting DIA	Flute LGTH	SHK DIA	OAL
10-00	1/16	3/16	1/4	2
10-01	3/32	3/8	1/4	2
10-02	1/8	3/8	1/4	2
10-20	1/8	1/2	1/4	2
10-22	3/16	3/4	1/4	2
10-06	1/4	3/4	1/4	2-1/8
10-07	1/4	1	1/4	2-3/8
10-78	1/4	1-1/4	1/4	2-5/8



Single & Double Flute - High Speed Steel O Flute Straight

Designed for cutting softer more flexible plastics. Single flute for faster feed rates. Double flute for smoother finish. Excellent for hand-fed operations.

Usage ABS, polycarbonate, polyethylene, polystyrene, PVC, polypropylene extruded acrylic, HDPE, UHMW

Material **SP** **HP** See Selection Guide - pg. 2 - 12

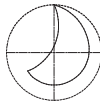

Single Flute

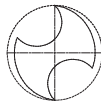

Double Flute

SINGLE FLUTE

Part Number	Cutting DIA	Flute LGTH	SHK DIA	OAL
11-01	1/8	1/2	1/4	2
11-75*	1/8	5/8	1/4	3-1/4
11-03	3/16	5/8	1/4	3-1/4
11-77*	3/16	3/4	1/4	3-1/4
11-05	1/4	3/4	1/4	2-1/8
11-71*	1/4	3/4	1/4	3-1/4
11-07	1/4	1	1/4	2-3/8
11-09	3/8	1	3/8	2-1/2

DOUBLE FLUTE

Part Number	Cutting DIA	Flute LGTH	SHK DIA	OAL
11-00	3/16	5/8	1/4	2
11-02	1/4	3/4	1/4	2-1/8
11-72*	1/4	3/4	1/4	3-1/4
11-76*	1/4	3/4	1/4	3-3/4
11-04	1/4	1	1/4	2-3/8
11-78*	1/4	2	1/4	3-1/4
11-06	3/8	1	3/8	2-1/2
11-74*	3/8	1	3/8	3-1/2

*These tools are designed and toleranced for Air Routers with guide bushing.



Double Flute - High Speed Steel V Flute Straight

These V flutes are often selected when a balanced tool is critical for smooth finish. A universal tool used in many environments. Excellent for hand-fed applications.

Usage Foam and natural wood

Material **HW** **FP** See Selection Guide - pg. 2 - 12

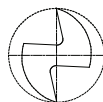

Part Number	Cutting DIA	Flute LGTH	SHK DIA	OAL
12-00	1/4	3/4	1/4	2-1/8
12-79*	1/4	1	1/4	3-1/4
12-35	1/4	1	1/2	2-1/2
12-05	3/8	1	3/8	2-1/2
12-10	1/2	1-1/4	1/2	2-3/4

* These tools are designed and toleranced for Air Routers with guide bushing.



15-50



Single Flute - High Speed Steel Dor-Bits

Designed to rout steel doors.

Usage Metal clad doors
(15-50 and TIN15-50)
Fiberglass doors (TIN15-50)

Material  See Selection Guide - pg. 2 - 12

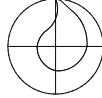

Part Number	Cutting DIA	Flute LGTH	SHK DIA	OAL	Door Machine
15-52	1/2	2-1/4	1/2	5-1/4	RUVO
15-53	1/2	2-1/2	1/2	5-1/2	RUVO
15-54	1/2	2-1/2	1/2	5	ACE
15-55*	1/2	2-1/2	1/2	5-1/2	FALCON
15-57*	1/2	2-1/2	1/2	5-1/2	NORFIELD
15-60	1/2	2-1/2	1/2	5-1/2	RUVO
15-61*	1/2	2-1/2	1/2	5-1/2	

HELIX ANGLE $\approx 18^\circ - 32^\circ$

*Have Flats

TIN COATED

Part Number	Cutting DIA	Flute LGTH	SHK DIA	OAL	Door Machine
TIN15-52	1/2	2-1/4	1/2	5-1/4	RUVO
TIN15-53	1/2	2-1/2	1/2	5-1/2	RUVO
TIN15-54	1/2	2-1/2	1/2	5	ACE
TIN15-55*	1/2	2-1/2	1/2	5-1/2	FALCON
TIN15-57*	1/2	2-1/2	1/2	5-1/2	NORFIELD
TIN15-60	1/2	2-1/2	1/2	5-1/2	RUVO
TIN15-61*	1/2	2-1/2	1/2	5-1/2	

*HAVE FLATS

15-75



Three Flute - High Speed Steel TIN Coated CNC Dor-Bits

Downcut tools designed specifically for machining metal clad doors in a CNC environment. The tool geometry facilitates piercing steel and produces a superior cut for door lites and hardware openings.

Usage Metal clad or fiberglass doors

Material  See Selection Guide - pg. 2 - 12

TiN COATED

Part Number	Cutting DIA	Flute LGTH	SHK DIA	OAL	Door Machine
TIN15-75	1/2	3	1/2	6	KVAL

HELIX ANGLE $\approx 18^\circ$

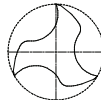

18-00



Single Flute - High Speed Steel Straight Pilot

Straight flute tools with boring points and pilots are the workhorse of the mobile home, modular home and RV industries.

Usage Wood panels, vinyl coated panels, wall board and aluminum layered materials

Material  See Selection Guide - pg. 2 - 12

Part Number	Cutting DIA	Flute LGTH	SHK DIA	OAL
18-00	1/4	3/4	1/4	2-3/4
18-02	3/8	7/8	3/8	2-7/8
18-03	1/2	1	1/2	3-1/2

20-00

Single Flute - High Speed Steel Downcut Spiral Pilot

Spiral tools designed to push chips away from the operator in mobile home and RV manufacturing plants.

Usage Aluminum and plywood sandwich panels, vinyl coated panels, wall board, drywall and layered material

Material  See Selection Guide - pg. 2 - 12

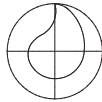

Part Number	Cutting DIA	Flute LGTH	SHK DIA	OAL
20-00	1/4	3/4	1/4	3
20-02	3/8	1	3/8	3-7/16
20-03	1/2	1-1/4	1/2	4

HELIX ANGLE \approx 21° - 38°



Single Flute - High Speed Steel Drywall Bit

Spiral flute tools designed to make cut outs in drywall. Used in manufactured housing and on site construction.

Usage Drywall cut outs

Material  See Selection Guide - pg. 2 - 12

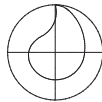

Part Number	Cutting DIA	Flute LGTH	SHK DIA	OAL
20-10	3/16	1	1/4	3-1/4
20-11	1/8	3/4	1/8	2-1/2
20-15	1/8	1	1/8	2-1/2

HELIX ANGLE \approx 30° - 41°

20-10

Single Flute - Solid Carbide Laminate Trim

Designed to trim counter tops. The pilot bears on the finished surface and acts as a guide to trim flush or with a bevel. Available with boring point if necessary to plunge and rout.

Usage Trimming laminate counter tops and trimming plastic parts

Material  See Selection Guide - pg. 2 - 12

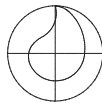

Part Number	Cutting DIA	Flute LGTH	SHK DIA	OAL	Style
27-00	1/4	1/4	1/4	1-1/2	Flush
27-01	1/4	1/4	1/4	1-1/2	7° Bevel
27-03	1/4	3/8	1/4	2	Flush

27-00

Double Flute - Solid Carbide Laminate Trim

Tools with a pilot designed to give a satin smooth finish when trimming laminate counter tops.

Usage Trimming laminate counter tops and trimming plastic parts

Material  See Selection Guide - pg. 2 - 12

Part Number	Cutting DIA	Flute LGTH	SHK DIA	OAL	Style
27-50	1/4	7/16	1/4	1-5/8	Flush

27-50

28-20



Solid Carbide Double-Bearing Plastic Trim

Spirals designed to trim stacked sheets of plastic in hand-fed applications. They use a double bearing guide to ensure smooth cutting action around a template.

Part Number	Cutting DIA	Flute LGTH	SHK DIA	OAL	Flute
28-20	1/4	3/4	1/4	3	2
28-25	1/2	1-1/8	1/2	4	2

HELIX ANGLE ~ 11° - 30°

Usage Trimming stacked sheets plastic & laminates

Material **SP** **HP** See Selection Guide - pg. 2 - 12

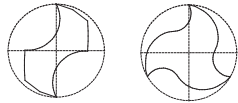

Double Flute Three Flute

REPLACEMENT BEARING KITS FOR SERIES 28-20 Solid Carbide Double Bearing Plastic Trim Tool Kits

28-89	KIT for 28-20 Tool
28-88	KIT for 28-25 Tool

28-50



Carbide Tipped Flush Trim

Designed to provide a smooth finished edge on dense, abrasive and laminated materials. A ball bearing guide assists free cutting action. Excellent for hand-fed applications.

Part Number	Cutting DIA	Flute LGTH	SHK DIA	OAL	Flute
28-55	1/4	1	1/4	2-1/2	2
28-51	3/8	1/2	1/4	2-1/4	2
28-50	3/8	1	1/4	2-3/4	2
28-53	1/2	1/2	1/4	2	2
28-57	1/2	1	1/4	2-3/4	3
28-54	1/2	1	1/2	3-1/4	2
28-63	1/2	1-1/2	1/2	4-1/4	2
28-64	1/2	2	1/2	4-1/4	2

Usage Natural wood, wood composites, laminated and veneered

Material **SW** **HW** **CW**
LW **SP**
See Selection Guide - pg. 2 - 12

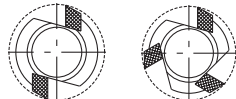

Double Flute Three Flute

29-50



Double Flute - Carbide Tipped Chamfer

Provides a beveled or decorative edge on finished parts.

Usage Natural wood and wood composites

Material **SW** **HW** **CW**
See Selection Guide - pg. 2 - 12

Part Number	Bevel	Flute LGTH	SHK DIA	OAL
29-51	45°	1/2	1/4	2
29-52	45°	1/2	1/2	2-1/2
29-53	25°	3/8	1/4	1-7/8

37-00
37-20

Single Flute - Solid Carbide Engraving Tools

The half round engraving tools are offered with a wide range of tip sizes and angles to accommodate many engraving styles.

Usage Wood, plastic, aluminum and solid surface

Material SW HW SP HP A SSP

See Selection Guide - pg. 2 - 12

Part Number	TIP	Angle	SHK DIA	OAL
37-21	0.005	30	1/4	2
37-23	0.010	30	1/4	2
37-25	0.020	30	1/4	2
37-27	0.030	30	1/4	2
37-29	0.040	30	1/4	2
37-31	0.060	30	1/4	2
37-35	0.090	30	1/4	2
37-39	30 Degree Kit			

METRIC

Part Number	TIP	Angle	SHK DIA	OAL
37-25M	0.5mm	30	6mm	50mm
37-27M	0.76mm	30	6mm	50mm
37-29M	1mm	30	6mm	50mm

Part Number	TIP	Angle	SHK DIA	OAL
37-01	0.005	60	1/4	2
37-03	0.010	60	1/4	2
37-05	0.020	60	1/4	2
37-07	0.030	60	1/4	2
37-09	0.040	60	1/4	2
37-11	0.060	60	1/4	2
37-15	0.090	60	1/4	2
37-19	60 Degree Kit			

METRIC

Part Number	TIP	Angle	SHK DIA	OAL
37-05M	0.5mm	60	6mm	50mm
37-07M	0.76mm	60	6mm	50mm
37-09M	1mm	60	6mm	50mm

Double Flute - V Bottom

Designed for V grooving or beveling 90°.

Usage Plastic and solid surface, composites, laminated and veneer

Material SW HW CW SP HP SSP LW

See Selection Guide - pg. 2 - 12

SOLID CARBIDE

Part Number	Cutting DIA	Flute LGTH	SHK DIA	OAL
37-50	3/16	5/8	1/4	2
37-51	1/4	3/4	1/4	2
37-52	3/8	3/4	3/8	2-1/2

HELIX ANGLE ≈ 3° - 5° Shear

CARBIDE TIPPED

Part Number	Cutting DIA	Flute LGTH	SHK DIA	OAL
37-61	1/2	13/32	1/4	1-25/32
37-62	3/4	1/2	1/2	2-1/8
37-63	1	27/32	1/2	2-27/32

37-50
37-60

37-70



Double Flute - Carbide Tipped Folding Tool for Dibond/Alucobond

Designed for cutting aluminum/plastic sandwich materials with 90° angle and flat bottom.

Usage Aluminum/plastic sandwich materials

Material  See Selection Guide - pg. 2 - 12

Part Number	Cutting DIA	Flute LGTH	SHK DIA	OAL
37-71	1/2	3/8	1/4	2
37-72	1/2	3/8	1/2	2

90° angle and .090 flat for folding material



37-80



Double Flute - Carbide Tipped Lettering Bits

Designed for V grooving or beveling edges of parts. The tools are designed to cut a wide variety of wood products and produce a clean edge.

Usage Wood

Material  See Selection Guide - pg. 2 - 12

Part Number	Cutting DIA	Flute LGTH	SHK DIA	OAL	ANGLE
37-82	1	0.856	1/2	3-1/2	60°
37-87	1-1/2	0.750	1/2	3	90°
37-92	2	0.577	1/2	3	120°
37-97	2	0.363	1/2	2-5/8	140°

40-50



Double Flute - Carbide Tipped Round & Rout

Designed to put a radius on the edge and dress the stock. They will provide a smooth finish.

Usage Natural wood, wood composites, plastic and solid surface

Material  See Selection Guide - pg. 2 - 12

Part Number	Cutting DIA	Sm Cutting DIA	Flute LGTH	SHK DIA	OAL	RAD	Material Thickness
40-50	1	1/2	.938	1/2	3-3/16	3/16	3/4
40-52	1-1/8	1/2	.937	1/2	3-3/16	1/4	3/4
40-54	1-3/8	1/2	.938	1/2	3-3/16	3/8	3/4
40-55	1-3/8	1/2	1.437	1/2	3-11/16	3/8	1-3/8

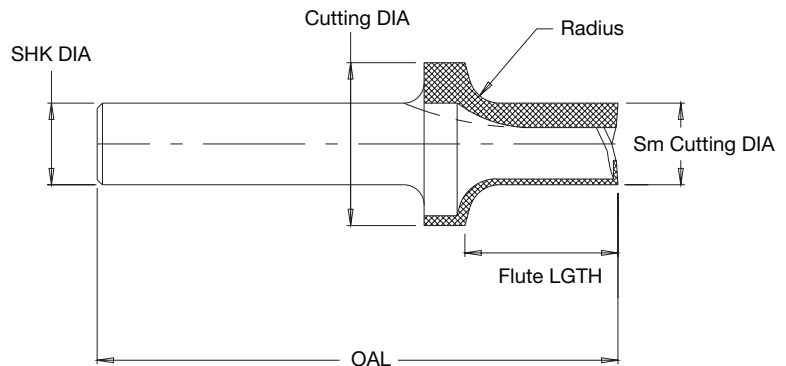

42-00

Double Flute - Carbide Tipped Corner Round

Quarter round profile tools feature up shear geometry for better finishes.

Usage Natural wood, wood composites and solid surface

Material **SW HW CW SSP**
See Selection Guide - pg. 2 - 12

Part Number	Radius	Cutting DIA	Flute LGTH	SHK DIA	OAL
42-10	1/8	3/4	3/8	1/4	2-1/8
42-03	5/32	13/16	15/32	1/4	2-3/32
42-01	3/16	7/8	1/2	1/4	2
42-02	1/4	1	7/16	1/4	1-29/32
42-04	5/16	1-1/8	9/16	1/4	2-1/4
42-05	3/8	1-1/4	5/8	1/4	2-1/32
42-06	1/2	1-1/2	3/4	1/4	2-5/32
42-07	1/2	1-1/2	3/4	1/2	2-11/16
42-08	3/4	2	1-1/32	1/2	3



Double Flute - Carbide Tipped MDF Panel Tools

These cutters can create 12 cabinet combinations by combining different stile and panel cutters to get the desired shape in MDF material.

Usage MDF

Material **CW** See Selection Guide - pg. 2 - 12

Part Number	Cutting DIA	SHK DIA	OAL	Description
47-02	7/8	1/2	2-1/2	Bead Profile - Stile Bits
47-04	1-1/4	1/2	2-1/2	Traditional Profile - Stile Bits
47-06	1-1/4	1/2	2-1/2	Ogee Profile - Stile Bits
47-08	1-1/4	1/2	2-1/2	Straight Profile - Stile Bits
47-10	1-1/2	1/2	2-1/2	Cove Profile - Panel Bits
47-12	1-1/2	1/2	2-1/2	Straight Profile - Panel Bits
47-14	1-1/2	1/2	2-1/2	Ogee Profile - Panel Bits

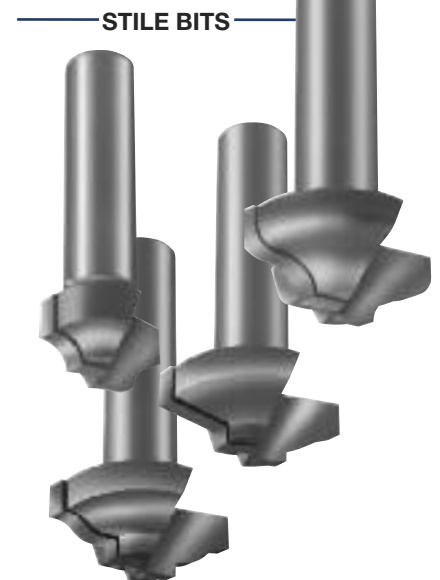

TOOL COMBINATIONS

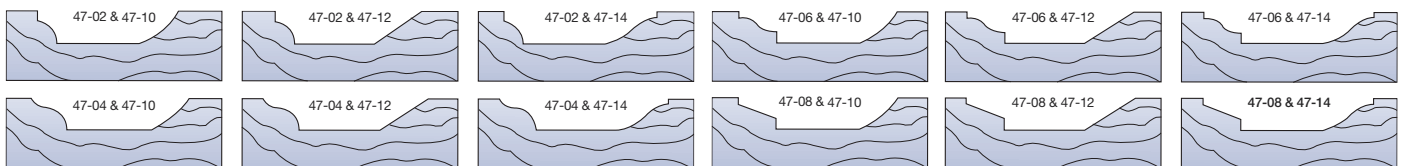

T Slot

Designed to bore a hole and rout a T shape slot for plaques and frames to provide for built in wall mounting capabilities.

Usage Natural wood, wood composites

Material **SW HW CW**
See Selection Guide - pg. 2 - 12

SOLID CARBIDE

Part Number	Cutting DIA	Flute LGTH	Neck	SHK DIA	OAL	Flutes
90-06	3/8	3/8	3/16	1/4	1-5/8	2

90-00



29-000



HSS Hollow Core Cutters

This specialized cutter is designed to vertically cut the honeycomb cells producing a clean, flag free edge. The core material will remain attached at the bottom and can be removed using one of our valve style honeycomb cutters. This product along with our 31-100 or 30-000 series tools is an effective combination to create pockets in honeycomb core and get a perfectly clean edge.

Usage Honeycomb

Part Number	Cutting DIA	Flute LGTH	SHK DIA	OAL
29-003	1/4	1-1/2	1/4	3-3/4
29-006	3/8	1-7/8	3/8	3-3/4
29-009	1/2	2-7/8	1/2	5
29-012	5/8	2-7/8	5/8	5
29-015	3/4	2-7/8	3/4	5

29-050



Diamond Grit Hogger

Diamond grit hoggers are used on abrasive cores (graphite, phenolic, or fiberglass) in order to achieve long tool life. The tools are available in a ball nose version and as a traditional hogger capable of holding existing honeycomb blades. A 35% weight reduction has been designed into the larger diameter tools resulting in better performance on 3 or 5 axis machines.

Usage Honeycomb



BALL NOSE

Part Number	Cutting DIA	Flute LGTH	SHK DIA	OAL
29-053	1/4 (6.35mm)	1 1/4	1/4	4
29-058	3/8 (9.52mm)	2 1/2	1/2	4
29-063	1/2 (12.7mm)	3	1/2	5
29-068	3/4 (19.05mm)	3	1/2	5
29-074	1 (25.4mm)	2	3/4	4

HONEYCOMB HOGGER					CUTTING BLADE OPTIONS							SPARE PARTS	
Part #	Cutting Diameter	Hogger Depth	Shank DIA	OAL	Blade Diameter	HSS	HSS w/Teeth	Solid Carbide	Solid Carbide w/Teeth	Diamond Plated	HSS Saw	Adapter Ring	Screw
29-052	1/4 (6.35mm)	1 1/4	1/4	4	-	-	-	-	-	-	-	-	-
29-057	.345 (8.76mm)	2 1/2	1/2	4	3/8 (9.52mm)	30-016	30-316	-	-	-	-	-	HRD51646
29-062	.470 (11.94mm)	3	1/2	5	1/2 (12.7mm)	30-017	30-317	-	-	-	-	-	HRD51646
29-067	.720 (18.28mm)	3	1/2	5	3/4 (19.05mm)	-	-	30-015	30-318	-	-	-	30-011-2
29-072	.970 (24.63mm)	1	1/2	3	1 (25.4mm)	-	-	30-012	30-313	30-113	30-213	-	30-011-2
29-073'	.970 (24.63mm)	2	3/4	5	1 (25.4mm)	-	-	30-012	30-313	30-113	30-213	-	30-011-2
29-078	1.470 (37.33mm)	1	1/2	3	1 1/2 (38.10mm)	-	-	30-014	30-314	30-114	30-214	30-020-3	30-020-4
29-079'	1.470 (37.33mm)	2	3/4	5	1 1/2 (38.10mm)	-	-	30-014	30-314	30-114	30-214	30-020-3	30-020-4
29-083	1.742 (44.24mm)	1	1/2	3	1.772 (45mm)	-	-	30-026	30-326	30-126°	30-226°	30-020-3	30-020-4
29-084'	1.742 (44.24mm)	2	3/4	5	1.772 (45mm)	-	-	30-026	30-326	30-126°	30-226°	30-020-3	30-020-4
29-088	1.970 (50.03mm)	1	5/8	3	2 (50.8mm)	-	-	30-022	30-322	30-122	30-222	30-020-3	30-020-4
29-089'	1.970 (50.03mm)	2	3/4	5	2 (50.8mm)	-	-	30-022	30-322	30-122	30-222	30-020-3	30-020-4
29-093	2.450 (62.23mm)	1	5/8	3	2.480 (63mm)	-	-	30-036	30-336	30-136	30-236	30-030-3	30-030-4
29-095	2.970 (75.43mm)	1	3/4	3	3 (76.20mm)	-	-	30-032	30-332	30-132	30-232	30-030-3	30-030-4
29-096'	2.970 (75.43mm)	1	3/4	4	3 (76.20mm)	-	-	30-032	30-332	30-132	30-232	30-030-3	30-030-4
29-098	3.970 (100.83mm)	1	3/4	3	4 (101.6mm)	-	-	30-042	30-342	30-142	30-242	30-040-3	30-040-4
29-099'	3.970 (100.83mm)	1	3/4	4	4 (101.6mm)	-	-	30-042	30-342	30-142	30-242	30-040-3	30-040-4

1 = non-stock standard. 4 week lead time
2 = 50mm diameter honecomb blade

See page 22 or 24 for Images of Cutting Blades
See Page 72 for Wrench and Torque Spec

Solid Carbide Honeycomb Hogger (Coated)

Designed to be a versatile tool and cut most honeycomb core materials. The solid carbide body offers long tool life while the proven hogger geometry shreds the core and evacuates chips. The long flute length allows for deep pocket applications and can also be used to surface large areas. Hoggers are coated with ZRN.

Usage Honeycomb

METRIC

Part Number	Cutting DIA	Flute LGTH	SHK DIA	OAL
29-120	12 (.472")	60	12	150
29-135	16 (.629")	80	16	150

Part Number	Cutting DIA	Flute LGTH	SHK DIA	OAL
29-110	1/4 (6.35mm)	1-1/4	1/4	4
29-115	3/8 (9.52mm)	2	3/8	4
29-125	1/2 (12.7mm)	3	1/2	6
29-130	1/2 (12.7mm)	4-1/2	1/2	6-1/2
29-140	3/4 (19.05mm)	3	3/4	6
29-145	3/4 (19.05mm)	4-1/2	3/4	6-1/2

BALLNOSE

Part Number	Cutting DIA	Flute LGTH	SHK DIA	OAL
29-130B	1/2 (12.7mm)	4-1/2	1/2	6-1/2
29-140B	3/4 (19.05mm)	3	3/4	6
29-145B	3/4 (19.05mm)	4-1/2	3/4	6-1/2

29-100/
29-100B

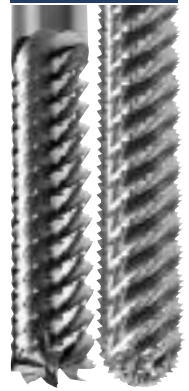

Replaceable Ring Type Honeycomb Cutter

These tools are for contouring, carving and chamfering cuts of .25" or less. The unique patented holding system prevents the solid carbide blades from coming out of the holder if it is fractured.

The HSS saw blades and the diamond plated blades dish on the bottom so they clear the cut core finish like the hollow ground solid carbide style rings. The solid carbide rings may be reground several times at the factory making them very economical to use.

The HSS saw and diamond plated blades are disposable, offering the convenience of a constant diameter.

Usage For contouring, carving and chamfering cuts

30-000



SHANK ASSEMBLY			CUTTING BLADE OPTIONS				SPARE PARTS	
Part #	Blade Diameter	Shank DIA	Solid Carbide	Solid Carbide with Teeth	Diamond Plated	HSS Saw	Adapter Ring	Screw
30-011	1" (25.4mm)	1/2	30-012	30-313	30-112	30-213	-	30-011-2
30-021	2" (50.8mm)	1/2	30-022	30-322	30-122	30-222	30-020-3	30-020-4
30-031	3" (76.2mm)	1/2	30-032	30-332	30-132	30-232	30-030-3	30-030-4
30-041	4" (101.6mm)	1/2	30-042	30-342	30-142	30-242	30-040-3	30-040-4

See page 22 or 24 for Images of Cutting Blades

See Page 72 for Wrench and Torque Spec

Cutting Blades for Cutters and Hoggers

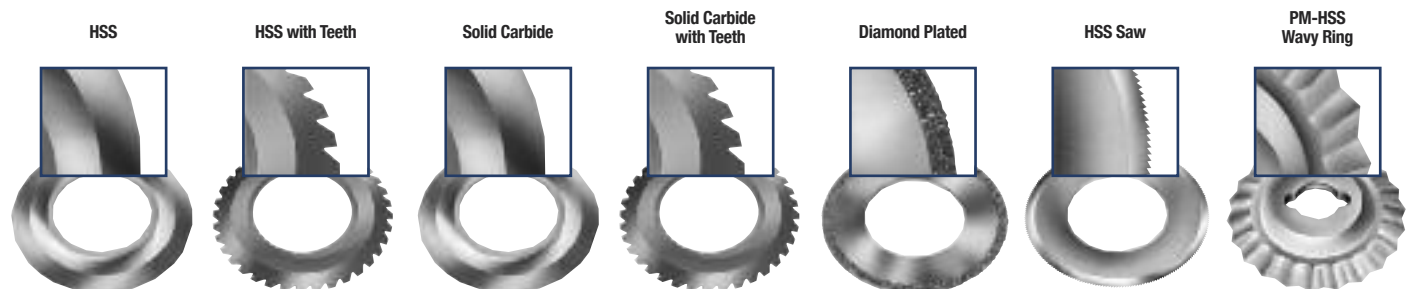

30-300

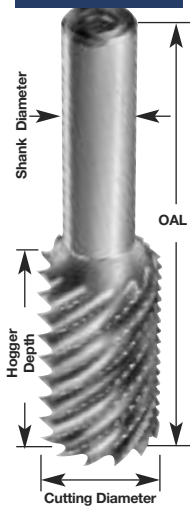

HSS Integral Shank Honeycomb Hogger Cutter

**High Speed Steel Hogsers • High Speed Replaceable Saw Blade
Solid Carbide Replaceable Blade • Diamond Plated Replaceable Blade**
The spiral hogger geometry ground integral to the shank allows for faster feed rates and deeper cuts than any previous cutter. The availability of several different blades makes this cutter suitable for most core types. The hogger design also imparts less force as it evacuates and shreds scrap.



Usage CNC machining of honeycomb core

HONEYCOMB HOGGER					CUTTING BLADE OPTIONS					SPARE PARTS	
Part #	Cutting Diameter	Hogger Depth	Shank DIA	OAL	Blade Diameter	Solid Carbide	Solid Carbide w/Teeth	Diamond Plated	HSS Saw	Adapter Ring	Screw
30-310	7/8 (22.22mm)	1 1/2	1/2	3 1/2	1 (25.4mm)	30-012	30-313	30-113	30-213	-	30-011-2
30-315	1 1/4 (31.75mm)	1 1/2	1/2	3 1/2	1 1/2 (38.1mm)	30-014	30-314	30-114	30-214	30-020-3	30-020-4
30-321	1 3/4 (44.45mm)	1 1/2	1/2	3 1/2	2 (50.8mm)	30-022	30-322	30-122	30-222	30-020-3	30-020-4
30-331	2 3/4 (69.85mm)	1	1/2	3 1/2	3 (76.2mm)	30-032	30-332	30-132	30-232	30-030-3	30-030-4
30-341	3 3/4 (95.25mm)	1	3/4	3 1/2	4 (101.6mm)	30-042	30-342	30-142	30-242	30-040-3	30-040-4

See page 22 or 24 for Images of Cutting Blades

See Page 72 for Wrench and Torque Spec

30-700



Reduced Weight Honeycomb Cutter

35% weight reduction has been designed into the larger diameter tools resulting in better performance on 3 or 5 axis machines. Part lifting and flagging have also been reduced due to the new tooth and flute design. Existing honeycomb blades will mount on these hogsers.

Usage CNC Machining of Honeycomb Core

HONEYCOMB HOGGER					CUTTING BLADE OPTIONS							SPARE PARTS	
Part #	Cutting Diameter	Hogger Depth	Shank DIA	OAL	Blade Diameter	HSS	HSS w/Teeth	Solid Carbide	Solid Carbide w/Teeth	Diamond Plated	HSS Saw	Adapter Ring	Screw
30-703	.345 (8.76mm)	1	1/2	3	3/8 (9.52mm)	30-016	30-316	-	-	-	-	-	HRD51646
30-705	.470 (11.93mm)	1	1/2	3	1/2 (12.7mm)	30-017	30-317	-	-	-	-	-	HRD51646
30-707	.720 (18.28mm)	1	1/2	3	3/4 (19.05mm)	-	-	30-015	30-318	-	-	-	30-011-2
30-710	.970 (24.63mm)	1	1/2	3	1 (25.4mm)	-	-	30-012	30-313	30-113	30-213	-	30-011-2
30-715	1.470 (37.33mm)	1	1/2	3	1 1/2 (38.10mm)	-	-	30-014	30-314	30-114	30-214	30-020-3	30-020-4
30-720	1.742 (44.24mm)	1	1/2	3	1.772 (45mm)	-	-	30-026	30-326	30-126 ¹	30-226 ¹	30-020-3	30-020-4
30-725	1.970 (50.03mm)	1	5/8	3	2 (50.8mm)	-	-	30-022	30-322	30-122	30-222	30-020-3	30-020-4
30-730	2.450 (62.23mm)	1	5/8	3	2.480 (63mm)	-	-	30-036	30-336	30-136	30-236	30-030-3	30-030-4
30-735	2.970 (75.43mm)	1	3/4	3	3 (76.20mm)	-	-	30-032	30-332	30-132	30-232	30-030-3	30-030-4
30-740	3.970 (100.83mm)	1	3/4	3	4 (101.6mm)	-	-	30-042	30-342	30-142	30-242	30-040-3	30-040-4

1 = 50mm diameter honecomb blade

See page 22 or 24 for Images of Cutting Blades

See Page 72 for Wrench and Torque Spec

High Speed Steel Cutter

Designed primarily for use on aluminum core, offering the versatility of smaller sizes for use on hand-held machines in field or maintenance type repairs. This cutter offers the strength of an integral shank and blade that has an edge sharpness unattainable with any other material. This sharpness and the relieved bottom yield part surfaces that require a minimum of preparation before bonding operation.

Usage Aluminum Core

Part Number	Cutting DIA	SHK DIA	OAL
31-010	1/2	1/4	2-1/16
31-015	3/4	1/4	2-3/32
31-020	1	1/4	2-1/8
31-025	1-1/2	1/2	2-1/4
31-030	2	1/2	2-3/4
31-040	3	1/2	2-15/16



Core Type	Rating
Aluminum, Lo Density (Less than 5#/cuft)	1
Aluminum, Hi Density (More than 5#/cuft)	2
Paper	2
Paper, Reinforced	N
Fiberglass	N
Phenolic	N
Polycarbonate	N
Aramid	N

1 - Excellent, 2 - Good, N - Not Recommended

High Speed Steel Honeycomb Cutter With Teeth

Small diameter honeycomb cutters were designed to offer the flexibility of cutting small slots or pockets in honeycomb core. The tools are versatile and can be used on CNC machines or hand held machines for field or maintenance type repairs.

Usage For contouring, carving, pocketing, and chamfer cuts

Part Number	Cutting DIA	SHK DIA	OAL
31-102TCN	3/8	1/4	3
31-104TCN	1/2	1/4	3
31-106TCN	5/8	1/4	3
31-108TCN	3/4	1/4	3



Cutting Blades for Cutters and Hoggers

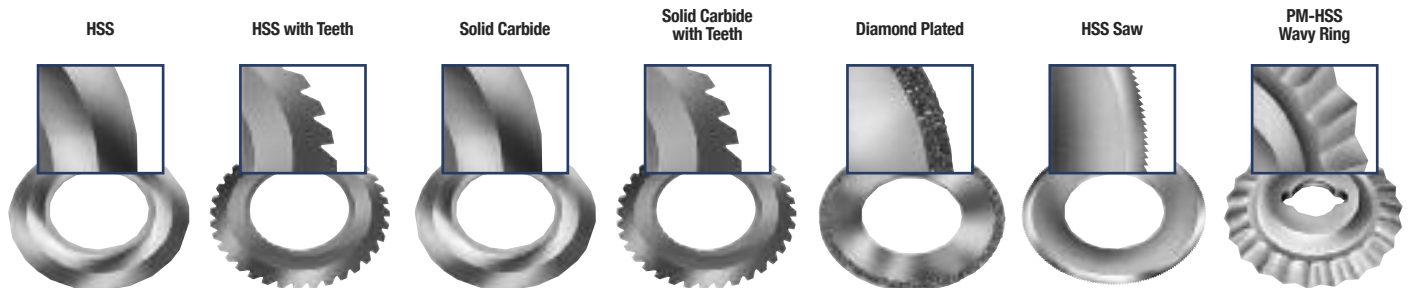

32-000

High Speed Steel Hogger



These cutters are specifically designed for fast (low force) removal of excess core followed by a final finish pass to obtain excellent finishes with one tool. These cutters enable cuts of up to .60" depths in a single pass. The availability of several different blades makes this cutter suitable for most core types. All assemblies require a shank, hogger and blade.

Usage Fast removal of excess core



HONEYCOMB HOGGER			SHANK		CUTTING BLADE OPTIONS					SPARE PARTS	
Part #	Cutting Diameter	Hogger Depth	Part #	Shank DIA	Blade Diameter	Solid Carbide	Diamond Plated	HSS Wavy Ring	HSS Saw	Adapter Ring	Screw
32-022	1.732 (44mm)	.629 (16mm)	32-021	1/2	1.771 (45mm)	32-026	-	32-023	-	-	-
					1.968 (50mm)	-	32-029*	-	32-027*	32-028	-
32-032	2.421 (61.5mm)	.629 (16mm)	32-031	1/2	2.480 (63mm)	32-036	-	32-033	-	-	-
					2.952 (75mm)	-	32-039*	-	32-037*	32-038	-

32-100 - Wrench for 32-000 Tools

See page 13 or 15 for Images of Cutting Blades

* Requires Adapter Ring

32-200

HSS Three Piece Honeycomb Hogger (Coated)



Designed with more aggressive hogger geometry than the 32-000 series. Both the hogger and blade with teeth have a fine tooth grind pattern resulting in increased feed rates and improved part finish. All hoggers and blades are coated with a ZRN coating for increase in tool life. All hogger assemblies require a shank, a hogger and a blade. This design also allows the tool to be use without the hogger by replacing the hogger with a spacer. Torque Spec = 18 in-lb.

Usage Fast removal of excess core

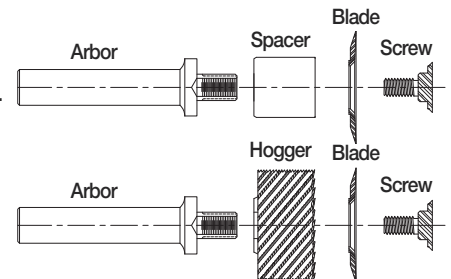

HONEYCOMB HOGGER			SHANK			CUTTING BLADE OPTIONS			SPARE PARTS	
Part #	Cutting Diameter	Hogger Depth	Part #	Shank DIA	OAL	Blade Diameter	Solid Carbide	Solid Carbide w/Teeth	Spacer	Retaining Screw
32-210	0.94" (23.88mm)	1" (25.4mm)	32-221	3/8"	4"	1" (25.4mm)	32-412	32-512	32-221-3	32-221-4
32-225	1.94" (49.28mm)	1" (25.4mm)	32-231	1/2"	4"	2" (50.8mm)	32-422	32-522	32-231-3	32-231-4
			32-241	5/8"	4"					
32-235	2.94" (74.68mm)	1" (25.4mm)	32-231	1/2"	4"	3" (76.2mm)	32-432	32-532	32-231-3	32-231-4
			32-241	5/8"	4"					
32-220	1.72" (43.69mm)	1" (25.4mm)	32-231	1/2"	4"	1.77" (45mm)	32-426	32-526	32-231-3	32-231-4
			32-241	5/8"	4"					
32-230	2.42" (61.47mm)	1" (25.4mm)	32-231	1/2"	4"	2.48" (63mm)	32-436	32-536	32-231-3	32-231-4
			32-241	5/8"	4"					

32-201 - Wrench for 32-200 Tools (for Shank Diameters 1/2" & 5/8")

32-202 - Wrench for 32-200 Tools (for Shank Diameters 3/8")

See page 13 or 15 for Images of Cutting Blades

Aircraft Panel Tools

This modular tool is designed to produce slots in composite panels so potting compound can be applied to strengthen the edge. This tool consists of a PCD arbor which accepts a diamond grit or HSS under cutting tool to be screwed into it.

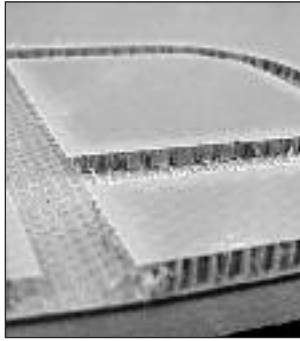

Usage HCC Panels

Part Number	Cutting DIA	Flute LGTH	SHK DIA	
34-008	1/2	-	1/2	Arbor (non-cutting)
34-010	1/2	1/4	1/2	PCD Arbor
34-022	7/8	0.130	n/a	Diamond Grit Cutter
34-024	7/8	0.250	n/a	Diamond Grit Cutter
34-026	7/8	0.380	n/a	Diamond Grit Cutter
34-028	7/8	0.500	n/a	Diamond Grit Cutter
34-030	7/8	0.630	n/a	Diamond Grit Cutter
34-042	7/8	0.130	n/a	HSS Cutter
34-044	7/8	0.250	n/a	HSS Cutter
34-046	7/8	0.380	n/a	HSS Cutter
34-048	7/8	0.500	n/a	HSS Cutter
34-050	7/8	0.630	n/a	HSS Cutter

34-000



Single Flute - High Speed Steel Upcut Spiral

Designed for routing applications where speed and chip removal are primary considerations. They are also recommended when grooving, slotting or blind routing.

Usage Natural wood, sheet and stacked aluminum

Material



See Selection Guide - pg. 2 - 12

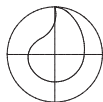

Part Number	Cutting DIA	Flute LGTH	SHK DIA	OAL
40-001	1/8	3/8	1/4	2-5/8
40-003	3/16	5/8	1/4	2-7/8
40-005	1/4	5/8	1/4	2-3/4
40-009	1/4	3/4	1/2	3-1/4
40-021	5/16	3/4	1/2	3-1/4
40-023	5/16	1	1/2	3-1/2
40-025	21/64	3/4	1/2	3-1/4
40-033	3/8	1	1/2	3-1/2

HELIX ANGLE = 19° - 32° Shear

40-000



Single Flute - High Speed Steel Downcut Spiral

Designed for through cut routing operations where speed is the primary concern and fixturing is such that both chips and material are better off forced down.

Usage Sheet aluminum

Material

See Selection Guide - pg. 2 - 12

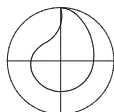

Part Number	Cutting DIA	Flute LGTH	SHK DIA	OAL
40-008	1/4	3/4	1/4	2 3/4
40-012	1/4	1	1/4	3

HELIX ANGLE = 19° - 32° Shear

40-000



40-100



Double Flute - High Speed Steel Upcut Spiral

Provides a smoother finish when grooving, slotting or blind routing than do single flute tools. Recommended when fixturing requires upward chip removal.

Usage Natural wood sheet, block & plate aluminum

Material



See Selection Guide - pg. 2 - 12

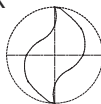

Part Number	Cutting DIA	Flute LGTH	SHK DIA	OAL
40-101	1/8	3/8	1/4	2-5/8
40-103	3/16	5/8	1/4	2-7/8
40-153	7/32	7/8	1/4	3
40-105	1/4	5/8	1/4	2-3/4
40-107	1/4	3/4	1/4	2-3/4

Part Number	Cutting DIA	Flute LGTH	SHK DIA	OAL
40-107	1/4	3/4	1/4	2-3/4
40-109	1/4	3/4	1/2	3-1/4
40-111*	1/4	1	1/4	3
40-121	5/16	3/4	1/2	3-1/4
40-117	5/16	3/4	3/8	3
40-115	5/16	1	5/16	3
40-123	5/16	1	1/2	3-1/2
40-131*	3/8	1	3/8	3
40-133	3/8	1	1/2	3-1/2
40-135	3/8	1-1/4	1/2	3-3/4
40-137	1/2	1-1/4	1/2	3-1/4
40-139	1/2	1-1/2	1/2	3-1/2
40-141	3/4	1-1/4	1/2	3-1/4

HELIX ANGLE = 19° - 32° Shear

* These tools are designed and tolerated for air routers with guide bushings.

40-100



Double Flute - High Speed Steel Downcut Spiral

Provides a smoother finish than single flute in trimming and sizing. Recommended when chip flow should be directed down to protect the finish on the top of the material being cut.

Usage Natural wood sheet & aluminum extrusions

Material



See Selection Guide - pg. 2 - 12

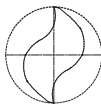

Part Number	Cutting DIA	Flute LGTH	SHK DIA	OAL
40-102	1/8	5/16	1/4	2-5/8
40-104	3/16	5/8	1/4	2-7/8
40-106	1/4	5/8	1/4	2-3/4
40-108	1/4	3/4	1/4	2-3/4
40-110	1/4	3/4	1/2	3-1/4
40-112*	1/4	1	1/4	3
40-158*	1/4	1	1/4	3-1/4
40-122	5/16	3/4	1/2	3-1/4
40-116	5/16	1	5/16	3
40-124	5/16	1	1/2	3-1/2
40-134	3/8	1	1/2	3-1/2
40-138	1/2	1-1/4	1/2	3-1/4
40-140	1/2	1-1/2	1/2	3-1/2
40-142	3/4	1-1/4	1/2	3-1/4

HELIX ANGLE = 19° - 32° Shear

* These tools are designed and tolerated for air routers with guide bushings.

40-550



Four Flute - High Speed Steel Upcut Spiral Foam Cutters

Designed to cut thick foam with upward chipflow.

Usage Foam

Material



See Selection Guide - pg. 2 - 12

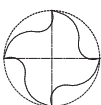

Part Number	Cutting DIA	Flute LGTH	SHK DIA	OAL
40-562	1/2	3-5/8	1/2	6
40-564	1/2	4-1/8	1/2	6-1/2

HELIX ANGLE = 25°

48-000

Single Flute - Carbide Tipped Straight

Designed for general usage where faster feed rates, free cutting action and long tool life are essential.

Usage Natural wood, wood composites, composite plastic and foam

Material HW CW CP FP

See Selection Guide - pg. 2 - 12

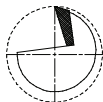

Part Number	Cutting DIA	Flute LGTH	SHK DIA	OAL
48-005	1/4	7/8	1/4	2-3/8
48-007	1/4	1	1/4	2-3/8
48-079*	1/4	1	1/4	3-1/4
48-056	3/8	1-1/4	1/2	2-3/4
48-069	1/2	1-1/2	1/2	3

* These tools are designed and toleranced for Air Routers with guide bushings.

**48-000**

Double Flute - Carbide Tipped Straight

Designed for general usage where superior balance and vibration free cutting provides a smoother finish along with long tool life.

Usage Natural wood, wood composites, composite plastic and foam

Material HW CW CP FP

See Selection Guide - pg. 2 - 12



Part Number	Cutting DIA	Flute LGTH	SHK DIA	OAL
48-008+	1/8	5/16	1/4	2
48-004	1/4	5/8	1/4	2-1/8
48-006	1/4	7/8	1/4	2-3/8
48-018	1/4	7/8	1/2	2-1/2
48-106	1/4	1	1/4	2-3/8
48-179*	1/4	1	1/4	3-1/4
48-017	5/16	3/4	1/2	2-1/4
48-010	5/16	1	1/4	2-1/2
48-012	3/8	3/4	1/4	2-1/4
48-036*	3/8	1	3/8	2-1/2
48-057	3/8	1	1/2	2-1/2
48-058*	3/8	1-1/4	3/8	3
48-158	3/8	1-1/4	1/2	2-3/4
48-014	1/2	3/4	1/4	2-1/8
48-072	1/2	1	1/2	2-1/2
48-076	1/2	1-1/4	1/2	2-3/4
48-080	1/2	1-1/2	1/2	3
48-081	1/2	2	1/2	4
48-183	1/2	2-1/2	1/2	4-1/2
48-015	5/8	1	1/4	2-1/4
48-086	5/8	1-1/4	1/2	2-3/4
48-016	3/4	1	1/4	2-1/4
48-088	3/4	1-1/4	1/2	3
48-215	3/4	2	3/4	4
48-096	7/8	1-1/4	1/2	2-3/4
48-100	1	1-1/4	1/2	2-3/4

+ Solid Carbide

*These tools are designed and toleranced for Air Routers with guide bushings.



49-000



Double Flute - High Speed Steel Downcut

These double flute downcuts with a drill type point were developed initially as "Aircraft Throwaway" tools. They have many uses in trimming and routing primarily with hand held routers.

Usage Aluminum

Material  See Selection Guide - pg. 2 - 12

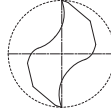

Part Number	Cutting DIA	Flute LGTH	SHK DIA	OAL
49-005	1/4	9/16	1/4	2 1/2
49-001	1/4	9/16	1/4	2 3/4
49-007	1/4	9/16	1/4	3 1/4
49-003	3/8	3/4	3/8	2 1/2

THESE TOOLS ARE DESIGNED AND TOLERANCED FOR AIR ROUTERS WITH GUIDE BUSHINGS, + .000 - .006
HELIX ANGLE = 24°

52-000



Double Flute - Solid Carbide Upcut Spiral

Designed as a general purpose spiral with several times the life of their high speed steel counterparts. They are used when upward chip flow is preferred.

Usage Fiberglass, phenolic, acetal, solid surface and aluminum slab

Material    See Selection Guide - pg. 2 - 12

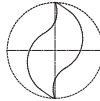

Part Number	Cutting DIA	Flute LGTH	SHK DIA	OAL
52-040	1/8	1/2	1/4	2
52-050	5/32	9/16	1/4	2
52-060	3/16	5/8	1/4	2
52-080	1/4	3/4	1/4	2-1/2
52-100	5/16	13/16	3/8	2-1/2
52-120	3/8	7/8	3/8	2-1/2
52-160	1/2	1	1/2	3

HELIX ANGLE = 30°

52-200



Double Flute - Solid Carbide Upcut Spiral Wood Rout

Designed for routing where upward chip removal, tool rigidity, long life and high quality finish is desired.

Usage Natural wood, wood composites solid surface, and some plastic

Material     See Selection Guide - pg. 2 - 12

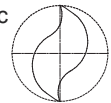

Part Number	Cutting DIA	Flute LGTH	SHK DIA	OAL
52-244	1/8	1/2	1/8	2
52-240	1/8	1/2	1/4	2
52-250	5/32	5/8	1/4	2
52-260	3/16	3/4	1/4	2
52-261	3/16	3/4	1/4	2-1/2
52-280	1/4	7/8	1/4	2-1/2
52-285	1/4	1	1/4	2-1/2
52-287	1/4	1-1/8	1/4	3
52-300	5/16	1-1/8	5/16	3
52-310	5/16	1-1/8	1/2	3
52-310L	5/16	1-1/8	1/2	3
52-318*	3/8	1	3/8	3

Part Number	Cutting DIA	Flute LGTH	SHK DIA	OAL
52-320	3/8	1-1/8	3/8	3
52-325	3/8	1-1/4	3/8	3
52-330	3/8	1-1/4	1/2	3
52-340	7/16	1	1/2	3
52-360	1/2	1-1/8	1/2	3
52-362	1/2	1-1/4	1/2	3-1/2
52-365	1/2	1-5/8	1/2	3-1/2
52-365L	1/2	1-5/8	1/2	3-1/2
52-367	1/2	2-1/8	1/2	4
52-385	5/8	2-1/8	5/8	4
52-395	3/4	2-1/8	3/4	4

HELIX ANGLE = 30°

* Special Point (Improved Bottom Finish)

L = Left Hand Rotation

52-200B/BL

Double Flute - Solid Carbide Upcut Spiral Ball Nose

Designed for carving and modeling operations. Their improved tip geometry gives a superior cut compared to most ballnose endmills.

Usage Plastic, solid surface, block & plate aluminum natural wood and wood composite

Material SW HW CW SP HP A SSP

See Selection Guide - pg. 2 - 12

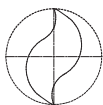

Part Number	Cutting DIA	Flute LGTH	SHK DIA	OAL
52-235B	1/16	1/4	1/8	2
52-244B	1/8	1/2	1/8	2
52-240B	1/8	1/2	1/4	2
52-260B	3/16	3/4	1/4	2
52-280B	1/4	7/8	1/4	2-1/2
52-320B	3/8	1-1/8	3/8	3
52-360B	1/2	1-1/8	1/2	3
52-386B	5/8	2-1/4	5/8	4
52-397B	3/4	2-1/2	3/4	5

METRIC

Part Number	Cutting DIA	Flute LGTH	SHK DIA	OAL
52-240BM	3mm	12mm	6mm	50mm
52-280BM	6mm	22mm	6mm	64mm
52-320BM	10mm	29mm	10mm	76mm
52-360BM	12mm	29mm	12mm	76mm

EXTENDED LENGTH

Part Number	Cutting DIA	Flute LGTH	ERL	SHK DIA	OAL
52-235BL	1/16	1/4	-	1/8	3
52-244BL	1/8	1/2	1-5/8	1/8	3
52-240BL	1/8	1/2	1-5/8	1/4	3
52-260BL	3/16	3/4	1-5/8	1/4	3
52-280BL	1/4	1	2-5/8	1/4	4
52-320BL	3/8	1-1/4	2-5/8	3/8	4
52-360BL	1/2	1-1/2	3-5/8	1/2	5
52-386BL	5/8	2-1/2	3-5/8	5/8	5
52-397BL	3/4	3	4-5/8	3/4	6



52-400

Double Flute - Solid Carbide Upcut Spiral Wood Rout

Designed for routing where upward chip removal, tool rigidity, long life and high quality finish is desired.

Usage Natural wood, wood composites, plastic and solid surface

Material SW HW CW SP

See Selection Guide - pg. 2 - 12

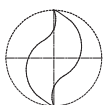

METRIC

Part Number	Cutting DIA	Flute LGTH	SHK DIA	OAL
52-410	4mm	16mm	6mm	64mm
52-411	5mm	20mm	6mm	64mm
52-412	6mm	25mm	6mm	64mm
52-414	8mm	25mm	8mm	64mm
52-416	10mm	35mm	10mm	76mm
52-418	12mm	35mm	12mm	76mm

HELIX ANGLE ≈ 30°



52-550

Double Flute - Solid Carbide Upcut Foam Cutters

Foam cutters for thick material with upward chip flow.

Usage Foam

Material FP See Selection Guide - pg. 2 - 12

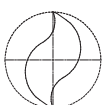

Part Number	Cutting DIA	Flute LGTH	SHK DIA	OAL
52-554	1/8	1-1/8	1/4	2-1/2
52-558	3/16	1-1/8	3/16	3
52-560	3/16	1-5/8	3/16	4
52-564	1/4	2-1/4	1/4	4
52-570	5/16	3-1/8	5/16	6
52-574	3/8	3-1/2	3/8	6

HELIX ANGLE ≈ 25°



52-600



Double Flute - Solid Carbide Upcut Spiral O Flute

Low helix geometry designed to cut soft and hard plastic with a smooth finish and upward chip flow.

Usage Soft and hard plastic, acrylic, nylon, ABS, PE, acetal, PET, HDPE, UHMW, polycarbonate and solid surface

Material **SP** **HP** **SSP**

See Selection Guide - pg. 2 - 12

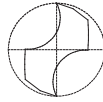

Part Number	Cutting DIA	Flute LGTH	SHK DIA	OAL
52-622	1/4	3/8	1/4	2-1/2
52-624	1/4	3/4	1/4	2-1/2
52-638	3/8	1	3/8	3
52-650	1/2	1-1/8	1/2	3-1/2
52-652	1/2	1-5/8	1/2	3-1/2
52-655	1/2	2-1/8	1/2	4-1/2
52-660	5/8	2-1/8	5/8	5
52-664	3/4	3-1/8	3/4	6

HELIX ANGLE ≈ 11°

52-700



Double Flute - Solid Carbide Upcut Spiral O Flute

High helix geometry designed to cut soft plastic with a smooth finish and upward chip flow. Special point geometry for improved bottom finish.

Usage Soft plastic, extruded acrylic, nylon, ABS, PE, acetal, PET, HDPE, UHMW, polycarbonate, solid surface and foam.

Material **SP** **SSP** **FP**

See Selection Guide - pg. 2 - 12

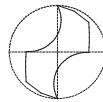

Part Number	Cutting DIA	Flute LGTH	SHK DIA	OAL
52-703	1/8	1/2	1/4	2
52-707	1/4	7/8	1/4	3
52-708	3/16	3/8	3/16	2-1/2
52-700	1/4	1-1/4	1/4	3
52-709	3/8	1	3/8	3
52-710	3/16	5/8	1/4	2-1/2
52-701	3/8	1-1/2	3/8	4
52-702	1/2	1-1/4	1/2	4
52-704	1/2	1-3/4	1/2	4
52-706	1/2	2-1/8	1/2	4
52-712	5/8	1-3/4	5/8	5
52-714	5/8	2-1/4	5/8	5
52-726	3/4	1-3/4	3/4	5
52-724	3/4	2-1/2	3/4	5
52-728	3/4	4	3/4	6-1/2
52-734	1	4	1	6-1/2

HELIX ANGLE ≈ 22°

METRIC

Part Number	Cutting DIA	Flute LGTH	SHK DIA	OAL
52-742	12mm	35mm	12mm	100mm
52-744	12mm	45mm	12mm	100mm
52-746	12mm	55mm	12mm	100mm
52-752	16mm	45mm	16mm	120mm
52-754	16mm	55mm	16mm	120mm
52-764	20mm	65mm	20mm	125mm

Double Flute - Solid Carbide Upcut Extreme Heavy Duty Standard

Developed for demanding applications where upward chip removal, tool rigidity and long life are essential to success.

Usage Natural wood and wood composites

Material **SW HW CW**

See Selection Guide - pg. 2 - 12

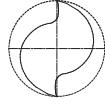

Part Number	Cutting DIA	Flute LGTH	SHK DIA	OAL
52-910	1/4	7/8	1/4	2-1/2
52-914	1/4	1-1/4	1/4	3
52-923	3/8	1-1/8	3/8	3
52-936	1/2	1-1/4	1/2	3

HELIX ANGLE = 30°

52-900



Three Flute - Solid Carbide Straight

Designed for routing extremely hard materials or when spindle RPM is lower than normal for routing.

Usage Composites

Material **CP** See Selection Guide - pg. 2 - 12

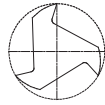

Part Number	Cutting DIA	Flute LGTH	SHK DIA	OAL
53-080	1/4	3/4	1/4	2-1/2

53-000



Three & Four Flute - Solid Carbide Spiral for Glass-Reinforced Plastic (Coated)

Updated line of three and four flute tools for machining glass-reinforced plastic. Geometry has been optimized to shear the glass fibers while creating a chip which removes heat from the cut to avoid melting of the material. Tools are coated to withstand the abrasive characteristics inherent to glass-reinforced plastic (GRP).

Usage Fiberglass and Composites

Material **CP** See Selection Guide - pg. 2 - 12

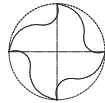

UPCUT

Part Number	Cutting DIA	Flute LGTH	SHK DIA	OAL	FLUTES
54-205	1/8	1/2	1/4	2-1/2	3
54-210	3/16	5/8	1/4	2-1/2	3
54-220	1/4	3/4	1/4	2-1/2	4
54-230	3/8	1-1/8	3/8	3	4
54-240	1/2	1-1/8	1/2	3-1/2	4

METRIC UPCUT

Part Number	Cutting DIA	Flute LGTH	SHK DIA	OAL	FLUTES
54-260	6mm	19mm	6mm	76mm	4
54-266	8mm	22mm	8mm	76mm	4
54-270	10mm	25mm	10mm	76mm	4
54-276	12mm	25mm	12mm	76mm	4

DOWNCUT

Part Number	Cutting DIA	Flute LGTH	SHK DIA	OAL	FLUTES
54-206	1/8	1/2	1/4	2-1/2	3
54-211	3/16	5/8	1/4	2-1/2	3
54-221	1/4	3/4	1/4	2-1/2	4
54-231	3/8	1-1/8	3/8	3	4
54-241	1/2	1-1/8	1/2	3-1/2	4

METRIC DOWNCUT

Part Number	Cutting DIA	Flute LGTH	SHK DIA	OAL	FLUTES
54-261	6mm	19mm	6mm	76mm	4
54-267	8mm	22mm	8mm	76mm	4
54-271	10mm	25mm	10mm	76mm	4
54-277	12mm	25mm	12mm	76mm	4

54-200



NEW

56-000



Double Flute - Solid Carbide Straight

Designed to rout composite plastic.

Usage Composite plastic

Material **HP CP SSP FP**

See Selection Guide - pg. 2 - 12

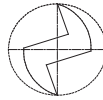

* These tools are designed and toleranced for air routers with guide bushings.

Part Number	Cutting DIA	Flute LGTH	SHK DIA	OAL
56-040	1/8	1/2	1/4	2
56-060	3/16	5/8	1/4	2
56-080	1/4	3/4	1/4	2-1/2
56-084*	1/4	3/4	1/4	3-1/4
56-100	5/16	13/16	3/8	2-1/2
56-160	1/2	1	1/2	3

56-000P



Double Flute - Solid Carbide Straight

Designed specifically to rout harder, more rigid plastics.

Usage Foam, fiberglass, phenolic, acrylic, nylon, PVC, ABS, acetal and solid surface

Material **HP CP SSP FP**

See Selection Guide - pg. 2 - 12

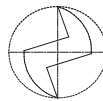

* These tools are designed and toleranced for air routers with guide bushings.

L = Left Hand Rotation

Part Number	Cutting DIA	Flute LGTH	SHK DIA	OAL
56-041	1/8	1/4	1/4	2
56-061	3/16	3/8	1/4	2
56-062	3/16	5/8	1/4	2
56-062L	3/16	5/8	1/4	2
56-063*	3/16	5/8	1/4	4
56-081	1/4	3/8	1/4	2-1/2
56-082	1/4	3/4	1/4	2-1/2
56-082L	1/4	3/4	1/4	2-1/2
56-086*	1/4	1-1/4	1/4	4
56-121	3/8	5/8	3/8	2-1/2
56-122	3/8	7/8	3/8	2-1/2
56-122L	3/8	7/8	3/8	2-1/2
56-124*	3/8	1-5/8	3/8	6
56-162	1/2	1	1/2	3
56-162L	1/2	1	1/2	3
56-164*	1/2	2-1/8	1/2	6

56-200



Double Flute - Solid Carbide Straight Wood Rout

Provides a superior finish in a variety of wood materials and optimum cutter life.

Usage Natural wood and wood composites

Material **SW HW CW**

See Selection Guide - pg. 2 - 12



Part Number	Cutting DIA	Flute LGTH	SHK DIA	OAL
56-240	1/8	1/2	1/4	2
56-250	5/32	5/8	1/4	2
56-260	3/16	3/4	1/4	2
56-270	7/32	3/4	1/4	2-1/2
56-280	1/4	7/8	1/4	2-1/2
56-285	1/4	1	1/4	2-1/2
56-287	1/4	1-1/8	1/4	3
56-300	5/16	1-1/8	5/16	3
56-310	5/16	1-1/8	1/2	3
56-320	3/8	1-1/8	3/8	3
56-330	3/8	1-1/4	1/2	3
56-360	1/2	1-1/8	1/2	3
56-365	1/2	1-5/8	1/2	3-1/2
56-390	3/4	1-5/8	3/4	4

Double Flute - Solid Carbide Straight O Flute

Designed with free cutting O flute geometry along with a double flute design for smooth finish.

Usage Polycarbonate, ABS, HIPS, HDPE, PET, acrylic, polystyrene, polypropylene, PE, PVC, acetal, UHMW

Material **SP** **HP**
See Selection Guide - pg. 2 - 12

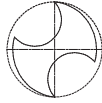

METRIC

Part Number	Cutting DIA	Flute LGTH	SHK DIA	OAL
56-430	4 mm	16 mm	6 mm	64 mm
56-431	5 mm	20 mm	6 mm	64 mm
56-432	6 mm	25 mm	6 mm	64 mm
56-434	8 mm	25 mm	8 mm	76 mm
56-436	10 mm	35 mm	10 mm	88 mm
56-438	12 mm	35 mm	12 mm	88 mm

56-430



Double Flute - Solid Carbide Straight

Designed specifically to rout harder, more rigid plastics

Usage Phenolic, acrylic, nylon, PVC, ABS, acetal and solid surface

Material **HP** **CP** **SSP**
See Selection Guide - pg. 2 - 12

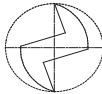

METRIC

Part Number	Cutting DIA	Flute LGTH	SHK DIA	OAL
56-450	4 mm	16 mm	6 mm	64 mm
56-451	5 mm	20 mm	6 mm	64 mm
56-452	6 mm	25 mm	6 mm	64 mm
56-454	8 mm	25 mm	8 mm	76 mm
56-456	10 mm	35 mm	10 mm	88 mm
56-458	12 mm	35 mm	12 mm	88 mm

56-450



Double Flute - Solid Carbide O Flute Straight

Designed with free cutting O flute geometry along with a double flute design for smooth finish.

Usage Polycarbonate, ABS, HIPS, HDPE, PET, acrylic, polystyrene, polypropylene, PE, PVC, acetal, UHMW

Material **SP** **HP**
See Selection Guide - pg. 2 - 12



Part Number	Cutting DIA	Flute LGTH	SHK DIA	OAL
56-610	1/8	5/16	1/4	2
56-612	1/8	1/2	1/4	2
56-614	1/8	5/8	1/4	4
56-616	3/16	3/8	1/4	2
56-618	3/16	5/8	1/4	2
56-620	3/16	1	1/4	4
56-624	1/4	3/8	1/4	2-1/2
56-625	1/4	1	1/4	2-1/2
56-625L	1/4	1	1/4	2-1/2
56-626	1/4	1	1/4	3-1/4
56-628	1/4	1-1/4	1/4	4
56-638	3/8	7/8	3/8	2-1/2
56-639	3/8	1	3/8	4
56-650	1/2	1	1/2	3
56-652	1/2	1	1/2	4
56-654	1/2	1-3/4	1/2	4
56-655	1/2	2-1/8	1/2	6

L = Left Hand Rotation

56-600



57-000



Double Flute - Solid Carbide Downcut Spiral

Designed as a general purpose spiral with several times the life of their high speed counterparts. They are used when a downward chipflow action is preferred.

Usage Aluminum and composite plastic

Material CP A

See Selection Guide - pg. 2 - 12

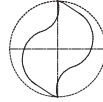

Part Number	Cutting DIA	Flute LGTH	SHK DIA	OAL
57-040	1/8	1/2	1/4	2
57-060	3/16	5/8	1/4	2
57-080	1/4	3/4	1/4	2-1/2
57-120	3/8	7/8	3/8	2-1/2
57-160	1/2	1	1/2	3

HELIX ANGLE = 30°

57-200



Double Flute - Solid Carbide Downcut Spiral Wood Rout

Designed for routing where downward chip removal, tool rigidity, long life, and high quality finish is desired.

Usage Natural wood and wood composites

Material SW HW CW

See Selection Guide - pg. 2 - 12

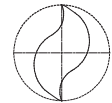

Part Number	Cutting DIA	Flute LGTH	SHK DIA	OAL
57-244	1/8	1/2	1/8	2
57-240	1/8	1/2	1/4	2
57-240L	1/8	1/2	1/4	2
57-251	5/32	1/2	1/4	2-1/2
57-250	5/32	5/8	1/4	2
57-260	3/16	3/4	1/4	2
57-261	3/16	3/4	1/4	2-1/2
57-270	7/32	3/4	1/4	2-1/2
57-280	1/4	7/8	1/4	2-1/2
57-285	1/4	1	1/4	2-1/2
57-285L	1/4	1	1/4	2-1/2
57-287	1/4	1-1/8	1/4	3
57-290	9/32	1	5/16	2-1/2
57-300	5/16	1-1/8	5/16	3
57-310	5/16	1-1/8	1/2	3
57-310L	5/16	1-1/8	1/2	3
57-318*	3/8	1	3/8	3

Part Number	Cutting DIA	Flute LGTH	SHK DIA	OAL
57-320	3/8	1-1/8	3/8	3
57-325	3/8	1-1/4	3/8	3
57-330	3/8	1-1/4	1/2	3
57-340	7/16	1	1/2	3
57-360	1/2	1-1/8	1/2	3
57-362	1/2	1-1/4	1/2	3-1/2
57-365	1/2	1-5/8	1/2	3-1/2
57-365L	1/2	1-5/8	1/2	3-1/2
57-367	1/2	2-1/8	1/2	4
57-370	17/32	1-1/8	1/2	3
57-380	5/8	1-5/8	5/8	3-1/2
57-385	5/8	2-1/8	5/8	4
57-390	3/4	1-5/8	3/4	4
57-395	3/4	2-1/8	3/4	4
57-395L	3/4	2-1/8	3/4	4

HELIX ANGLE = 30°

L = Left Hand Rotation

* Special Point (Improved Bottom Finish)

57-200MD



Double Flute - Marathon Wood Rout Downcut (Coated)

The longest running downcut in the industry due to advancements in geometry and the addition of a unique Onsrud coating.

Usage Wood composites

Material CW See Selection Guide - pg. 2 - 12

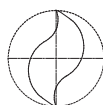

Part Number	Cutting DIA	Flute LGTH	SHK DIA	OAL
57-278MD	1/4	3/8	1/4	2-1/2
57-279MD	1/4	5/8	1/4	2-1/2
57-317MD	3/8	7/8	3/8	3
57-359MD	1/2	7/8	1/2	3

NEW

57-400**Double Flute - Solid Carbide Downtcut Spiral Wood Rout**

Designed for routing where downward chip removal, tool rigidity, long life, and high quality finish is desired.

Usage Natural wood and wood composites

Material **SW HW CW**

See Selection Guide - pg. 2 - 12

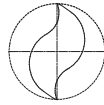
**METRIC**

Part Number	Cutting DIA	Flute LGTH	SHK DIA	OAL
57-410	4 mm	16 mm	6 mm	64 mm
57-411	5 mm	20 mm	6 mm	64 mm
57-412	6 mm	25 mm	6 mm	64 mm
57-414	8 mm	25 mm	8 mm	64 mm
57-416	10 mm	35 mm	10 mm	76 mm

HELIX ANGLE ≈ 30°

**Double Flute - Solid Carbide Downtcut Spiral O Flute**

Designed to cut plastic with a smooth finish and downward chip flow.

Usage Acrylic, nylon, ABS, PE, acetal, PET, HDPE, UHMW, polycarbonate and solid surface

Material **SP HP SSP**

See Selection Guide - pg. 2 - 12

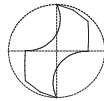

Part Number	Cutting DIA	Flute LGTH	SHK DIA	OAL
57-623	1/4	3/8	1/4	2-1/2
57-625	1/4	3/4	1/4	2-1/2
57-637	3/8	1	3/8	3
57-651	1/2	1-1/8	1/2	3-1/2

HELIX ANGLE ≈ 10-11°

METRIC

Part Number	Cutting DIA	Flute LGTH	SHK DIA	OAL
57-627	6mm	25mm	6mm	64mm
57-639	8mm	25mm	8mm	76mm

57-600**Double Flute - Solid Carbide Downtcut Extreme Heavy Duty Standard**

Designed for routing where extreme loads are placed upon the cutting tools and when extra part hold down is required.

Usage Natural wood and wood composites

Material **SW HW CW**

See Selection Guide - pg. 2 - 12

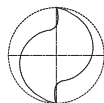

Part Number	Cutting DIA	Flute LGTH	SHK DIA	OAL
57-910	1/4	7/8	1/4	2-1/2
57-921	3/8	7/8	3/8	3
57-923	3/8	1-1/8	3/8	3
57-924	3/8	1-1/4	3/8	3
57-936	1/2	1-1/4	1/2	3
57-940	1/2	1-5/8	1/2	3-1/2

HELIX ANGLE ≈ 30°

57-900

60-000



Three Flute - Solid Carbide High Helix Hogger

Designed with unique scalloped cutting edge design for extremely fast machining and roughing. Faster chip removal with upcuts. Better hold down with downcuts.

Usage Natural wood & wood composites, hard & soft plastic and plastic composites

Material **SW HW CW**

See Selection Guide - pg. 2 - 12

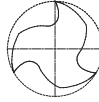

UPCUT

Part Number	Cutting DIA	Flute LGTH	SHK DIA	OAL
60-001	3/8	1-1/8	3/8	3-1/2
60-005	1/2	1-1/8	1/2	3-1/2
60-007	1/2	1-5/8	1/2	4
60-009	5/8	1-5/8	5/8	4
60-011	5/8	2-1/8	5/8	5
60-017	3/4	1-5/8	3/4	4
60-019	3/4	2-1/8	3/4	5

HELIX ANGLE ≈ 30°

DOWNCUT

Part Number	Cutting DIA	Flute LGTH	SHK DIA	OAL
60-002	3/8	1-1/8	3/8	3-1/2
60-006	1/2	1-1/8	1/2	3-1/2
60-008	1/2	1-5/8	1/2	4
60-012	5/8	2-1/8	5/8	5
60-018	3/4	1-5/8	3/4	4
60-020	3/4	2-1/8	3/4	5

60-000



Three Flute - Solid Carbide Low Helix Hogger

Designed with unique scalloped cutting geometry which provides extremely fast roughing, lower horsepower requirements, longer tool life, and reduced chipping in solid wood materials.

Usage Natural wood & wood composites, hard & soft plastic and plastic composites

Material **SW HW CW**

See Selection Guide - pg. 2 - 12

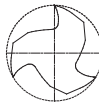

UPCUT

Part Number	Cutting DIA	Flute LGTH	SHK DIA	OAL
60-037	3/8	1-1/8	3/8	3-1/2
60-053	1/2	1-1/8	1/2	3-1/2
60-051	1/2	1-5/8	1/2	4
60-061	5/8	2-1/8	5/8	5
60-073	3/4	1-5/8	3/4	4
60-071	3/4	2-1/8	3/4	5

HELIX ANGLE ≈ 10°

DOWNCUT

Part Number	Cutting DIA	Flute LGTH	SHK DIA	OAL
60-038	3/8	1-1/8	3/8	3-1/2
60-054	1/2	1-1/8	1/2	3-1/2
60-052	1/2	1-5/8	1/2	4
60-074	3/4	1-5/8	3/4	5
60-072	3/4	2-1/8	3/4	5

Three Flute - Solid Carbide Upcut Lock Mortise

The scalloped upcut cutting edge design and extra spinback provide fast material removal in deep cuts for horizontal and vertical lock mortise routing.

Usage Natural wood and wood composites

Material **SW HW CW MT**
See Selection Guide - pg. 2 - 12

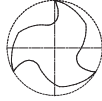

Part Number	Cutting DIA	Flute LGTH	Max DOC	SHK DIA	OAL
60-090	5/8	2	4-1/2	5/8	6-1/2

HELIX ANGLE ≈ 30°

METRIC

Part Number	Cutting DIA	Flute LGTH	Max DOC	SHK DIA	OAL
60-091	16 mm	50 mm	114 mm	16 mm	170 mm

HELIX ANGLE ≈ 30°

60-090



Double & Three Flute - Marathon Compression Spiral (Coated)

The LMT Onsrud Marathon is the longest running compression tool due to advancements in cutting geometry and the addition of a unique Onsrud coating. The coating is formulated to protect the cutting edge from the high temperatures generated when routing laminated and composite wood products.

Usage Double-sided laminated and Veneered Wood Composites

Material **CW** See Selection Guide - pg. 2 - 12

TWO FLUTE

Part Number	Cutting DIA	Flute LGTH	Upcut Flute LGTH	SHK DIA	OAL
60-123MC*	3/8	7/8	.200	3/8	3
60-124MC	3/8	1-1/8	.406	3/8	3
60-163MC*	1/2	7/8	.200	1/2	3
60-169MC	1/2	1-1/8	.562	1/2	3
60-171MC	1/2	1-3/8	.625	1/2	3-1/2
60-173MC*	1/2	1-3/8	.200	1/2	3-1/2
60-172MC	1/2	1-5/8	.750	1/2	4

* MORTISE COMPRESSION

THREE FLUTE

Part Number	Cutting DIA	Flute LGTH	Upcut Flute LGTH	SHK DIA	OAL
60-126MC*	3/8	7/8	.200	3/8	3
60-177MC*	1/2	1-3/8	.200	1/2	3-1/2

* MORTISE COMPRESSION

60-100MC



NEW

60-100MW

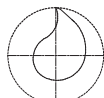

Single Flute

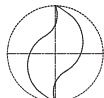

Double Flute

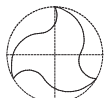

Three Flute

Single, Double & Three Flute - Solid Carbide *Max Life* Compression Spiral

Designed for maximum life when cutting in high-wear applications. Unique geometries and carbides improve the wear characteristics of the tool under abrasive applications with superior part finish. Mortise compressions are designed with short upcut to allow mortise cut with downcut action.

Usage Double sided laminated and veneered materials

Material **LW** See Selection Guide - pg. 2 - 12

DOUBLE FLUTE

Part Number	Cutting DIA	Flute LGTH	Upcut Flute LGTH	SHK DIA	OAL
60-113MW*	1/4	7/8	.188	1/4	2-1/2
60-123MW*	3/8	7/8	.188	3/8	3
60-124MW	3/8	1-1/8	.406	3/8	3
60-127MW*	3/8	1-1/8	.188	3/8	3
60-163MW*	1/2	7/8	.200	1/2	3
60-169MW	1/2	1-1/8	.562	1/2	3
60-171MW	1/2	1-3/8	.625	1/2	3-1/2
60-172MW	1/2	1-5/8	.750	1/2	4
60-173MW*	1/2	1-3/8	.200	1/2	3-1/2
60-181MW	1/2	2-1/8	1	1/2	5
60-186MW	5/8	2-1/4	1	5/8	5
60-196MW	3/4	1-7/8	.750	3/4	4
60-194MW	3/4	2-1/4	1	3/4	5

HELIX ANGLE ≈ 30°

*MORTISE COMPRESSION

SINGLE FLUTE

Part Number	Cutting DIA	Flute LGTH	Upcut Flute LGTH	SHK DIA	OAL
60-102MW	1/8	3/8	.205	1/4	2-1/2
60-106MW	3/16	5/8	.300	1/4	2-1/2
60-111MW*	1/4	7/8	.175	1/4	2-1/2
60-120MW*	3/8	1-1/8	.200	3/8	3
60-167MW*	1/2	1-1/8	.200	1/2	3

HELIX ANGLE ≈ 30°

*MORTISE COMPRESSION

THREE FLUTE

Part Number	Cutting DIA	Flute LGTH	Upcut Flute LGTH	SHK DIA	OAL
60-125MW	3/8	1-1/8	.500	3/8	3
60-126MW*	3/8	7/8	.200	3/8	3
60-176MW*	1/2	7/8	.200	1/2	3
60-177MW*	1/2	1-3/8	.200	1/2	3-1/2

*MORTISE COMPRESSION

60-100DC



Double Flute - Solid Carbide Compression Spiral

The Tuff Core is an innovative line of solid carbide compression spirals that utilize unique dual grade carbide. The harder outer shell is reinforced by a tough inner core which makes the tool stronger and reduces tool breakage.

Usage Double sided laminated, and veneered materials

Material **CW** See Selection Guide - pg. 2 - 12

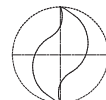

Double Flute

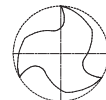

Three Flute

DOUBLE FLUTE

Part Number	Cutting DIA	Flute LGTH	Upcut Flute LGTH	SHK DIA	OAL
60-123DC*	3/8	7/8	.188	3/8	3
60-124DC	3/8	1-1/8	.406	3/8	3

THREE FLUTE

Part Number	Cutting DIA	Flute LGTH	Upcut Flute LGTH	SHK DIA	OAL
60-126DC*	3/8	7/8	.200	3/8	3

* MORTISE COMPRESSION

60-100C



Double Flute - Solid Carbide Chipbreaker/Finisher Compression Spiral

Designed to give the optimum edge finish of the compression spiral bits along with the increased feed rates of the chipbreaker/finisher design.

Usage Double sided laminated, veneered, natural wood and wood composites

Material **HW CW LW**
See Selection Guide - pg. 2 - 12

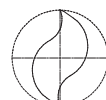

Part Number	Cutting DIA	Flute LGTH	Upcut Flute LGTH	SHK DIA	OAL
60-123C	3/8	7/8	.188	3/8	3
60-124C	3/8	1-1/8	.406	3/8	3
60-163C*	1/2	7/8	.200	1/2	3
60-169C	1/2	1-1/8	.562	1/2	3
60-171C	1/2	1-3/8	.625	1/2	3-1/2
60-172C	1/2	1-5/8	.750	1/2	4

HELIX ANGLE ≈ 30°

* MORTISE COMPRESSION

Single, Double, Three & Four Flute - Solid Carbide Compression Spiral

Compression design for optimum edge finish on both sides of laminated materials. Designed for low speed applications.

Usage Double sided laminated, veneered, natural wood and wood composites

Material **LW HW CW SW MT**
See Selection Guide - pg. 2 - 12

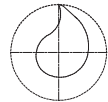

Single Flute

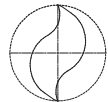

Double Flute

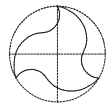

Three Flute



Four Flute

SINGLE FLUTE - SE

Part Number	Cutting DIA	Flute LGTH	Upcut Flute LGTH	SHK DIA	OAL
60-110	1/4	7/8	.531	1/4	2-1/2
60-111*	1/4	7/8	.175	1/4	2-1/2
60-120	3/8	1-1/8	.500	3/8	3
60-160	1/2	1	.406	1/2	3
60-165	1/2	1-5/8	.781	1/2	3-1/2

HELIX ANGLE ≈ 30°

* MORTISE COMPRESSION

DOUBLE FLUTE - DE

Part Number	Cutting DIA	Flute LGTH	Upcut Flute LGTH	SHK DIA	OAL
60-112	1/4	7/8	.531	1/4	2-1/2
60-113*	1/4	7/8	.188	1/4	2-1/2
60-123*	3/8	7/8	.188	3/8	3
60-124	3/8	1-1/8	.406	3/8	3
60-169	1/2	1-1/8	.562	1/2	3
60-172	1/2	1-5/8	.750	1/2	4
60-173*	1/2	1-3/8	.200	1/2	3-1/2
60-186	5/8	2-1/4	1	5/8	5

HELIX ANGLE ≈ 30°

* MORTISE COMPRESSION

THREE FLUTE - TE

Part Number	Cutting DIA	Flute LGTH	Upcut Flute LGTH	SHK DIA	OAL
60-125	3/8	1-1/8	.500	3/8	3
60-126*	3/8	7/8	.200	3/8	3
60-174	1/2	1-1/8	.500	1/2	3
60-175	1/2	1-5/8	.750	1/2	3-1/2
60-176*	1/2	7/8	.200	1/2	3
60-177*	1/2	1-3/8	.200	1/2	3-1/2

HELIX ANGLE ≈ 30°

* MORTISE COMPRESSION

FOUR FLUTE - FE

Part Number	Cutting DIA	Flute LGTH	Upcut Flute LGTH	SHK DIA	OAL
60-563*	1/2	7/8	.200	1/2	3
60-569	1/2	1-1/8	.500	1/2	3
60-573*	1/2	1-3/8	.200	1/2	3-1/2
60-572	1/2	1-5/8	.750	1/2	4

HELIX ANGLE ≈ 30°

* MORTISE COMPRESSION



60-200



Three Flute - Solid Carbide Low Helix Finisher

Designed for perfect balance and ultra smooth finish over a wide speed range.

Usage Natural wood, plastic, composite plastic and solid surface

Material **SW** **HW** **CW** **HP** **SSP**
See Selection Guide - pg. 2 - 12

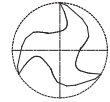

UPCUT

Part Number	Cutting DIA	Flute LGTH	SHK DIA	OAL
60-239	1/4	3/8	1/4	3
60-241	1/4	7/8	1/4	3
60-243	3/8	5/8	3/8	3
60-245	3/8	1-1/8	3/8	3
60-249	1/2	1-1/8	1/2	3-1/2
60-253	1/2	1-5/8	1/2	4
60-251	1/2	2-1/8	1/2	4-1/2
60-269	3/4	1-5/8	3/4	4
60-271	3/4	2-1/8	3/4	5
60-277	3/4	3-1/8	3/4	6

HELIX ANGLE ≈ 10°

DOWNCUT

Part Number	Cutting DIA	Flute LGTH	SHK DIA	OAL
60-240	1/4	3/8	1/4	3
60-242	1/4	7/8	1/4	3
60-244	3/8	5/8	3/8	3
60-246	3/8	1-1/8	3/8	3
60-250	1/2	1-1/8	1/2	3-1/2
60-254	1/2	1-5/8	1/2	4
60-252	1/2	2-1/8	1/2	4-1/2
60-270	3/4	1-5/8	3/4	5
60-272	3/4	2-1/8	3/4	5
60-278	3/4	3-1/8	3/4	6

HELIX ANGLE ≈ 10°

60-300



Double Flute - Solid Carbide Chipbreaker Finisher

For faster feed rates than a conventional two flute with a smooth finish.

Usage Natural wood and wood composites

Material **HW** **CW** See Selection Guide - pg. 2 - 12

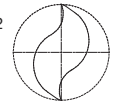

UPCUT

Part Number	Cutting DIA	Flute LGTH	SHK DIA	OAL
60-307	3/8	1-1/8	3/8	3
60-311	1/2	1-1/8	1/2	3
60-313	1/2	1-5/8	1/2	3-1/2
60-317	1/2	1-7/8	1/2	3-1/2
60-315	1/2	2-1/8	1/2	4
60-321	5/8	2-1/8	5/8	4
60-325	3/4	2-1/8	3/4	4

HELIX ANGLE ≈ 30°

DOWNCUT

Part Number	Cutting DIA	Flute LGTH	SHK DIA	OAL
60-308	3/8	1-1/8	3/8	3
60-312	1/2	1-1/8	1/2	3
60-314	1/2	1-5/8	1/2	3-1/2
60-318	1/2	1-7/8	1/2	3-1/2
60-316	1/2	2-1/8	1/2	4
60-322	5/8	2-1/8	5/8	4
60-326	3/4	2-1/8	3/4	4

60-350

Three Flute - Solid Carbide Chipbreaker Finisher

For additional balance at fast feed rates with a smooth finish.

Usage Natural wood and wood composites

Material SW HW CW

See Selection Guide - pg. 2 - 12

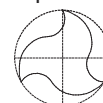

UPCUT

Part Number	Cutting DIA	Flute LGTH	SHK DIA	OAL
60-337	3/8	1-1/8	3/8	3
60-351	1/2	1-1/8	1/2	3
60-353	1/2	1-5/8	1/2	3-1/2
60-361	5/8	1-5/8	5/8	4
60-371	3/4	1-5/8	3/4	4
60-375	3/4	3-1/8	3/4	6

HELIX ANGLE ≈ 30°

DOWNCUT

Part Number	Cutting DIA	Flute LGTH	SHK DIA	OAL
60-338	3/8	1-1/8	3/8	3
60-350	1/2	1-1/8	1/2	3
60-354	1/2	1-3/8	1/2	3-1/2
60-352	1/2	1-5/8	1/2	3-1/2
60-360	5/8	1-5/8	5/8	4
60-370	3/4	1-5/8	3/4	4
60-372	3/4	2-1/4	3/4	5
60-374	3/4	3-1/8	3/4	6

Four Flute - Solid Carbide High Velocity Compression Spiral

Combine a roughing and finishing cut in one tool for rapid feed rates with a good finish.

Usage High velocity routing of double sided laminated and veneered, natural wood and wood composites

Material SW HW CW LW

See Selection Guide - pg. 2 - 12

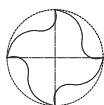

Part Number	Cutting DIA	Flute LGTH	Upcut Flute LGTH	SHK DIA	OAL
60-669	1/2	1-1/8	.500	1/2	3
60-671	1/2	1-3/8	.500	1/2	3-1/2

HELIX ANGLE ≈ 30°

60-600



Four Flute - Solid Carbide High Velocity Upcut Spiral

Combine a roughing and finishing cut with upcut cutting action in one tool for rapid feed rates with a good finish.

Usage High velocity routing of double sided laminated and veneered, natural wood and wood composites

Material SW HW CW

See Selection Guide - pg. 2 - 12



UPCUT

Part Number	Cutting DIA	Flute LGTH	SHK DIA	OAL
60-711	1/2	1-1/8	1/2	3-1/2
60-715	1/2	1-5/8	1/2	4
60-719	1/2	2-1/8	1/2	4-1/2
60-731	3/4	2-1/8	3/4	5

HELIX ANGLE ≈ 30°

DOWNCUT

Part Number	Cutting DIA	Flute LGTH	SHK DIA	OAL
60-710	1/2	1-1/8	1/2	3-1/2
60-714	1/2	1-5/8	1/2	4
60-718	1/2	2-1/8	1/2	4-1/2
60-720	5/8	2-1/8	5/8	5

HELIX ANGLE ≈ 30°

60-700



60-800



Double Flute - Solid Carbide Rougher

Designed for use when faster feed rates cannot be achieved, or on low horsepower machines.

Usage Natural wood and wood composites

Material SW HW CW

See Selection Guide - pg. 2 - 12

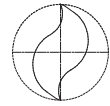

UPCUT

Part Number	Cutting DIA	Flute LGTH	SHK DIA	OAL
60-815	3/8	1-3/8	3/8	3-1/2
60-825	1/2	1-3/8	1/2	3-1/2
60-829	1/2	1-7/8	1/2	4
60-841	5/8	2-5/8	5/8	5
60-847	3/4	2-7/8	3/4	6

DOWNCUT

Part Number	Cutting DIA	Flute LGTH	SHK DIA	OAL
60-816	3/8	1-3/8	3/8	3-1/2
60-826	1/2	1-3/8	1/2	3-1/2
60-830	1/2	1-7/8	1/2	4
60-842	5/8	2-5/8	5/8	5
60-848	3/4	2-7/8	3/4	6

HELIX ANGLE ~ 20°

60-900



Three Flute - Solid Carbide Extreme Heavy Duty Hogger

Designed for heavy material removal operations where the cutter is subject to excessive cutting forces and finish is not a primary concern.

Usage Natural wood and wood composites, plastic composites

Material SW HW CW

See Selection Guide - pg. 2 - 12

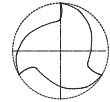

UPCUT

Part Number	Cutting DIA	Flute LGTH	SHK DIA	OAL
60-901	3/8	1-1/8	3/8	3
60-905	1/2	1-1/8	1/2	3
60-907	1/2	1-5/8	1/2	3-1/2
60-909	1/2	2-1/8	1/2	4
60-915	3/4	2-1/8	3/4	5

DOWNCUT

Part Number	Cutting DIA	Flute LGTH	SHK DIA	OAL
60-902	3/8	1-1/8	3/8	3
60-906	1/2	1-1/8	1/2	3
60-908	1/2	1-5/8	1/2	3-1/2
60-910	1/2	2-1/8	1/2	4
60-916	3/4	2-1/8	3/4	5

HELIX ANGLE ~ 30°

60-950



Double Flute - Solid Carbide Extreme Heavy Duty Chipbreaker/Finisher

Designed to be fed very fast while withstanding excessive cutting forces and at the same time leaving a smooth finish.

Usage Natural wood and wood composites

Material SW HW CW

See Selection Guide - pg. 2 - 12

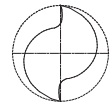

UPCUT

Part Number	Cutting DIA	Flute LGTH	SHK DIA	OAL
60-951	3/8	1-1/8	3/8	3
60-955	1/2	1-1/8	1/2	3
60-957	1/2	1-5/8	1/2	3-1/2
60-959	1/2	2-1/8	1/2	4
60-965	3/4	2-1/8	3/4	5

DOWNCUT

Part Number	Cutting DIA	Flute LGTH	SHK DIA	OAL
60-950	3/8	1-1/8	3/8	3
60-954	1/2	1-1/8	1/2	3
60-956	1/2	1-5/8	1/2	3-1/2
60-958	1/2	2-1/8	1/2	4

HELIX ANGLE ~ 30°

Single Flute - Solid Carbide Straight

Designed to combine the fast free cutting of O flute geometry with the tool life available from solid carbide particularly in small diameters.

Usage Natural wood and aluminum

Material



See Selection Guide - pg. 2 - 12

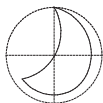

Part Number	Cutting DIA	Flute LGTH	SHK DIA	OAL
61-040	1/8	1/2	1/4	2
61-050	5/32	9/16	1/4	2
61-060	3/16	5/8	1/4	2
61-070	7/32	5/8	1/4	2-1/2
61-080	1/4	3/4	1/4	2-1/2
61-090	9/32	3/4	3/8	2-1/2
61-100	5/16	13/16	3/8	2-1/2
61-120	3/8	7/8	3/8	2-1/2
61-140	7/16	1	1/2	3
61-160	1/2	1	1/2	3



Single Flute - Solid Carbide Straight

Designed to combine the fast free cutting of O flute geometry with the tool life available from solid carbide particularly in small diameters.

Usage Polycarbonate, polyethylene, polypropylene, polystyrene, PVC, extruded acrylic, HDPE, UHMW and hard plastic

Material



See Selection Guide - pg. 2 - 12

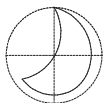

Part Number	Cutting DIA	Flute LGTH	SHK DIA	OAL
61-041	1/8	5/16	1/4	2
61-044	1/8	1/2	1/8	2
61-042	1/8	1/2	1/4	2
61-042L	1/8	1/2	1/4	2
61-045	1/8	5/8	1/8	3
61-043	1/8	5/8	1/4	4
61-052	5/32	9/16	1/4	2
61-061	3/16	3/8	1/4	2
61-064	3/16	5/8	3/16	2-1/2
61-062	3/16	5/8	1/4	2
61-062L	3/16	5/8	1/4	2
61-063*	3/16	1	1/4	4
61-072	7/32	5/8	1/4	2-1/2
61-081	1/4	3/8	1/4	2-1/2
61-082	1/4	3/4	1/4	2-1/2
61-082L	1/4	3/4	1/4	2-1/2
61-083*	1/4	3/4	1/4	3-1/4
61-083L*	1/4	3/4	1/4	3-1/4
61-085*	1/4	1	1/4	3-1/4
61-084*	1/4	1-1/4	1/4	4
61-121	3/8	5/8	3/8	2-1/2
61-122	3/8	7/8	3/8	2-1/2
61-123*	3/8	1-5/8	3/8	6
61-162	1/2	1	1/2	3
61-164	1/2	1-5/8	1/2	4
61-166	1/2	2-1/8	1/2	6



*These tools are designed and tolerated for air routers with guide bushings.
L= left hand rotation

61-200



Single Flute - Solid Carbide Straight Wood Rout

Designed to enhance operations where the benefits of spiral action are not needed. The single flute provides fast, free cutting with optimum cutter life.

Usage Natural wood and wood composites

Material **SW HW CW**

See Selection Guide - pg. 2 - 12

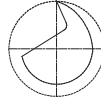

Part Number	Cutting DIA	Flute LGTH	SHK DIA	OAL
61-240	1/8	1/2	1/4	2
61-280	1/4	7/8	1/4	2-1/2
61-285	1/4	1	1/4	2-1/2
61-320	3/8	1-1/8	3/8	3

61-400



Single Flute - Solid Carbide Straight

Designed to combine the fast free cutting of O flute geometry with the tool life available from solid carbide particularly in small diameters.

Usage Polycarbonate, polyethylene, polypropylene, polystyrene, PVC, extruded acrylic, HDPE, UHMW and hard plastic

Material **SP HP**

See Selection Guide - pg. 2 - 12

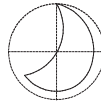

METRIC

Part Number	Cutting DIA	Flute LGTH	SHK DIA	OAL
61-410	4 mm	16 mm	6 mm	64 mm
61-411	5 mm	20 mm	6 mm	64 mm
61-412	6 mm	25 mm	6 mm	64 mm
61-414	8 mm	25 mm	8 mm	64 mm
61-418	12 mm	35 mm	12 mm	88 mm

62-600



Single Flute - Solid Carbide Downcut Spiral O Flute

High speed cutters for machining aluminum sheet material. These tools are optimized for use on high-speed CNC mills, high speed machining centers and CNC routers.

Usage Aluminum, plate, single & multi sheet

Material **A** See Selection Guide - pg. 2 - 12

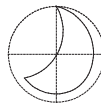

Part Number	Cutting DIA	Flute LGTH	SHK DIA	OAL
62-602	1/16	1/4	1/8	1-1/2
62-604	1/8	1/4	1/8	1-1/2
62-606	1/8	1/4	1/4	2
62-610	1/8	1/2	1/4	2
62-614	3/16	3/8	1/4	2
62-620	1/4	3/8	1/4	2
62-622	1/4	3/4	1/4	2-1/2
62-624	1/4	1-1/4	1/4	3
62-630	5/16	3/4	1/2	3
62-625	3/8	3/4	3/8	3
62-631	1/2	1-1/8	1/2	3-1/2

HELIX ANGLE ≈ 22°

Single Flute - Solid Carbide Downcut Spiral O Flute

(HP) Designed to provide a smooth finish in hard plastics with downward chip removal.

(SP) Designed to provide provide a smooth finish in soft plastic with downward chip removal.

Usage (HP): Acrylic, nylon, PVC, polycarbonate and solid surface
 (SP): HDPE, HIPS, UHMW, ABS, polycarbonate, PE, polystyrene, polypropylene, acetal, acrylic, PET and solid surface

Material 62-700 62-750 62-800 62-850

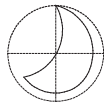

HARD PLASTIC		SOFT PLASTIC		Cutting DIA	Flute LGTH	SHK DIA	OAL
Part Number	Part Number						
62-713*	62-763*	1/8	1/2	1/8	2		
62-712*	62-762*	1/8	1/2	1/4	2		
62-715*		5/32	9/16	1/4	2		
62-719*	62-769*	3/16	5/8	3/16	2		
62-718	62-768	3/16	5/8	1/4	2		
62-725	62-775	1/4	3/4	1/4	2-1/2		
62-726	62-776	1/4	1-1/4	1/4	3		
62-727*		1/4	1-1/2	1/4	3		
62-733	62-783	3/8	1-1/8	3/8	3		
62-740	62-790	1/2	1-5/8	1/2	3-1/2		

* Tool balanced by design to run at spindle speeds up to 60,000 RPM

HARD PLASTIC		SOFT PLASTIC		METRIC	
Part Number	Part Number	Cutting DIA	Flute LGTH	SHK DIA	OAL
62-816*	62-866*	3mm	12mm	6mm	64mm
62-824*	62-874*	4mm	20mm	6mm	64mm
62-830	62-880	5mm	16mm	6mm	64mm
62-840		6mm	30mm	6mm	76mm
62-842*		6mm	38mm	6mm	76mm
62-844		8mm	25mm	8mm	64mm
62-846	62-896	8mm	38mm	8mm	76mm

HELIX ANGLE = 21°

* Tool balanced by design to run at spindle speeds up to 60,000 RPM

62-700
62-750
62-800
62-850



63-000



Single Flute - Solid Carbide Upcut Spiral

Designed for routing where upward chip removal, tool rigidity, long life, and high quality finish is desired.

Usage Fiberglass, phenolic and aluminum

Material See Selection Guide - pg. 2 - 12

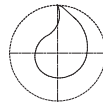

Part Number	Cutting DIA	Flute LGTH	SHK DIA	OAL
63-040	1/8	1/2	1/4	2
63-050	5/32	9/16	1/4	2
63-060	3/16	5/8	1/4	2
63-080	1/4	3/4	1/4	2-1/2
63-100	5/16	13/16	3/8	2-1/2
63-160	1/2	1	1/2	3

HELIX ANGLE = 30°

63-200**Single Flute - Solid Carbide Upcut Spiral Wood Rout**

Designed for routing where aggressive upward chip removal is necessary in hand-fed or CNC applications. Tool rigidity, long life, and high quality finish are characteristic of these tools.

Usage Natural wood and wood composites

Material **SW HW CW**

See Selection Guide - pg. 2 - 12

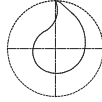

Part Number	Cutting DIA	Flute LGTH	SHK DIA	OAL
63-240	1/8	1/2	1/4	2
63-280	1/4	7/8	1/4	2-1/2

HELIX ANGLE ≈ 30°

63-400**Single Flute - Solid Carbide Upcut for Soft Aluminum (Coated)**

These tools are specially designed to cut soft grades of aluminum and create a good edge finish. The improved cutting geometry properly forms and evacuates the chips preventing chip rewelding.

Usage Soft aluminum sheet, 3003 grade aluminum

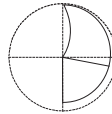

Part Number	Cutting DIA	Flute LGTH	SHK DIA	OAL	COATING
63-420	3/16	1/4	1/4	2	ZRN
63-430	1/4	1/4	1/4	2	ZRN

METRIC

Part Number	Cutting DIA	Flute LGTH	SHK DIA	OAL	COATING
63-450	5mm	6mm	6mm	64mm	ZRN
63-460	6mm	6mm	6mm	64mm	ZRN

CUTTING PARAMETERS

Part Number	RPM	Feed Rate
63-420	10,000	80 IPM
63-430	13,250	100 IPM
63-450	10,000	80 IPM
63-460	13,250	100 IPM

NEW

Single Flute - Solid Carbide Upcut Spiral O Flute for Acrylic

These tools are designed to cut acrylics and achieve long tool life. Our unique cutting geometry produces a smooth edge finish regardless if it is cast or extruded acrylic.

Usage Acrylic

Material **SP** **HP** See Selection Guide - pg. 2 - 12

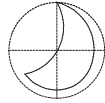

Part Number	Cutting DIA	Flute LGTH	SHK DIA	OAL
63-505*	1/16	1/4	1/4	2
63-510	1/8	1/4	1/4	2
63-515*	1/8	1/2	1/4	2
63-520*	3/16	5/8	1/4	2
63-525	1/4	3/8	1/4	2-1/2
63-530	1/4	3/4	1/4	2-1/2
63-535	3/8	1-1/8	3/8	3

* Tool balanced by design to run at spindle speeds up to 60,000 RPM

63-500



Single Flute - Solid Carbide Upcut Spiral O Flute

High speed cutters for machining aluminum sheet and block material. These tools are optimized for use on high-speed CNC mills, high speed machining centers and CNC routers.

Usage Aluminum plate and single/multi sheet aluminum

Material **A** See Selection Guide - pg. 2 - 12

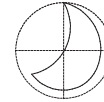

Part Number	Cutting DIA	Flute LGTH	SHK DIA	OAL
63-602	1/16	1/4	1/8	1-1/2
63-603	3/32	1/4	1/8	2
63-604	1/8	1/4	1/8	1-1/2
63-606	1/8	1/4	1/4	2
63-610	1/8	1/2	1/4	2
63-611	5/32	5/16	3/16	2
63-612	3/16	3/8	3/16	1-1/2
63-614	3/16	3/8	1/4	2
63-618	3/16	5/8	1/4	2
63-620	1/4	3/8	1/4	2

Part Number	Cutting DIA	Flute LGTH	SHK DIA	OAL
63-622	1/4	3/4	1/4	2-1/2
63-624	1/4	1 1/4	1/4	3
63-629	5/16	9/16	5/16	2-1/2
63-630	5/16	3/4	1/2	3
63-634	21/64	3/4	1/2	3
63-625	3/8	3/4	3/8	3
63-626	3/8	1-1/8	3/8	3
63-627	3/8	1-3/8	3/8	3-1/2
63-631	1/2	1-1/8	1/2	3-1/2
63-632	1/2	1-3/8	1/2	3-1/2

HELIX ANGLE = 22°

63-600



63-700
63-750
63-800
63-850



Single Flute - Solid Carbide Upcut Spiral O Flute

(HP) Designed to provide a smooth finish in hard plastics with upward chip removal.

(SP) Designed to provide a smooth finish in soft plastic with upward chip removal.

Usage (HP): Acrylic, nylon, PVC, polycarbonate and solid surface

(SP): HDPE, HIPS, UHMW, ABS, polycarbonate, PE, polystyrene, polypropylene, acetal, acrylic, PET and solid surface

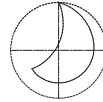

Material 63-700 **HP** **SSP** 63-750 **SP** **HP** **SSP**
63-800 **HP** **SSP** 63-850 **SP** **HP** **SSP**

HARD PLASTIC		SOFT PLASTIC				HARD PLASTIC		SOFT PLASTIC		METRIC	
Part Number	Part Number	Cutting DIA	Flute LGTH	SHK DIA	OAL	Part Number	Part Number	Cutting DIA	Flute LGTH	SHK DIA	OAL
63-701*	63-751*	1/16	1/4	1/8	2	63-802		2mm	8mm	2mm	50mm
63-700*	63-750*	1/16	1/4	1/4	2	63-804*	63-854	2mm	8mm	6mm	64mm
63-706*		1/8	5/8	1/4	2-1/2	63-806		2.5 mm	8mm	2.5mm	50mm
63-707*		1/8	3/4	1/4	2-1/2	63-808*		2.5 mm	8mm	6mm	64mm
63-711*	63-761*	1/8	1/4	1/8	2	63-810*	63-860*	3mm	8mm	3mm	50mm
63-710*	63-760*	1/8	1/4	1/4	2	63-812*	63-862*	3mm	8mm	6mm	64mm
63-713*	63-763*	1/8	1/2	1/8	2	63-814*	63-864*	3mm	12mm	3mm	64mm
63-712*	63-762*	1/8	1/2	1/4	2	63-816*	63-866*	3mm	12mm	6mm	64mm
63-743**	63-793**	1/8	1/2	1/4	2	63-818*		4mm	8mm	4mm	64mm
63-715*		5/32	9/16	1/4	2	63-820*	63-870*	4mm	12mm	4mm	64mm
63-716*	63-766*	3/16	3/8	3/16	2	63-822*		4mm	20mm	4mm	64mm
63-717*	63-767*	3/16	3/8	1/4	2	63-824*	63-874*	4mm	20mm	6mm	64mm
63-719*	63-769*	3/16	5/8	3/16	2	63-826*		4mm	30mm	4mm	64mm
63-718*	63-768*	3/16	5/8	1/4	2	63-828	63-878*	5mm	16mm	5mm	64mm
63-720		7/32	3/4	1/4	2-1/2	63-830	63-880	5mm	16mm	6mm	64mm
63-724	63-774	1/4	3/8	1/4	2	63-832		5mm	30mm	5mm	64mm
63-744**	63-794**	1/4	3/4	1/4	2-1/2	63-834		6mm	8mm	6mm	64mm
63-725	63-775	1/4	3/4	1/4	2-1/2	63-836	63-886	6mm	12mm	6mm	64mm
63-726	63-776	1/4	1-1/4	1/4	3	63-838	63-888	6mm	20mm	6mm	64mm
63-727*	63-777	1/4	1-1/2	1/4	3	63-840		6mm	30mm	6mm	76mm
63-730	63-780	3/8	5/8	3/8	2-1/2	63-842*	63-892*	6mm	38mm	6mm	76mm
63-731	63-781	3/8	3/4	3/8	3	63-844	63-894*	8mm	25mm	8mm	64mm
63-733	63-783	3/8	1-1/8	3/8	3	63-846	63-896	8mm	38mm	8mm	76mm
63-735	63-785	3/8	1-5/8	3/8	3-1/2	63-848	63-898	10mm	30mm	10mm	76mm
63-745**	63-795**	3/8	1-5/8	3/8	3-1/2	63-849		10mm	35mm	10mm	76mm
63-740	63-790	1/2	1-5/8	1/2	3-1/2	63-847	63-897	12mm	38mm	12mm	76mm
63-746**	63-796**	1/2	1-5/8	1/2	3-1/2						

HELIX ANGLE ≈ 21°

**Special Point for Improved Bottom Finish

HELIX ANGLE ≈ 21°

*** Tool balanced by design to run at spindle speeds up to 60,000 RPM**

Single Flute - Solid Carbide Upcut Spiral O Flute

63-900

High speed cutters for machining aluminum sheet and block material. These tools are optimized for use on high-speed CNC mills, high speed machining centers and CNC routers.

Usage Aluminum plate and single/multi sheet aluminum

Material  See Selection Guide - pg. 2 - 12

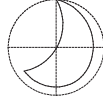

METRIC

Part Number	Cutting DIA	Flute LGTH	SHK DIA	OAL
63-904	2mm	6mm	6mm	64mm
63-908	2.5mm	6mm	6mm	64mm
63-912	3mm	8mm	6mm	64mm
63-916	3mm	12mm	6mm	64mm
63-918	4mm	8mm	4mm	64mm
63-924	4mm	20mm	6mm	64mm
63-930	5mm	16mm	6mm	64mm
63-934	6mm	8mm	6mm	64mm
63-938	6mm	20mm	6mm	64mm
63-944	8mm	25mm	8mm	64mm
63-946	8mm	38mm	8mm	76mm
63-948	10mm	30mm	10mm	76mm

HELIX ANGLE ≈ 22°



Single Flute - Solid Carbide Downcut Spiral O Flute

64-000

The polished flute allows for razor sharp cutting edge and easy chip evacuation. The tool is available in a down cut spiral for improved part holding.

Usage Plastic, wood, aluminum and solid surface

Material  See Selection Guide - pg. 2 - 12

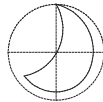

METRIC

Part Number	Cutting DIA	Flute LGTH	SHK DIA	OAL
64-012M	3mm	12mm	6mm	50mm
64-026M	6mm	32mm	6mm	76mm

HELIX ANGLE ≈ 21°

Part Number	Cutting DIA	Flute LGTH	SHK DIA	OAL
64-000*	1/16	1/4	1/8	2
64-012*	1/8	1/2	1/4	2
64-016*	3/16	3/8	3/16	2
64-018	3/16	5/8	1/4	2
64-024	1/4	3/8	1/4	2
64-025	1/4	3/4	1/4	2
64-026	1/4	1-1/4	1/4	3
64-031	3/8	3/4	3/8	3
64-033	3/8	1-1/8	3/8	3

HELIX ANGLE ≈ 21°

*** Tool balanced by design to run at spindle speeds up to 60,000 RPM**



65-000



Single Flute - Solid Carbide Upcut Spiral O Flute

The polished flute allows for razor sharp cutting edge and easy chip evacuation. The tool is available in a upcut spiral for improved chip evacuation.

Usage Plastic, wood, aluminum and solid surface

Material SW HW CW SP HP SSP A

See Selection Guide - pg. 2 - 12

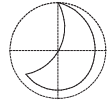

Part Number	Cutting DIA	Flute LGTH	SHK DIA	OAL
65-000*	1/16	1/4	1/8	2
65-010*	1/8	1/4	1/4	2
65-013*	1/8	1/2	1/8	2
65-012*	1/8	1/2	1/4	2
65-019*	3/16	5/8	3/16	2
65-018*	3/16	5/8	1/4	2
65-020*	3/16	1-1/4	1/4	3
65-021*	3/16	7/8	1/4	2-1/2
65-023	1/4	5/8	1/4	2

HELIX ANGLE = 21°

* Tool balanced by design to run at spindle speeds up to 60,000 RPM

Part Number	Cutting DIA	Flute LGTH	SHK DIA	OAL
65-025	1/4	7/8	1/4	2-1/2
65-026	1/4	1-1/4	1/4	3
65-027*	1/4	1-1/2	1/4	3
65-033	3/8	1-1/8	3/8	3

* Tool balanced by design to run at spindle speeds up to 60,000 RPM

METRIC

Part Number	Cutting DIA	Flute LGTH	SHK DIA	OAL
65-000M	2mm	6mm	3mm	50mm
65-018M	5mm	16mm	6mm	64mm
65-023M	6mm	16mm	6mm	64mm
65-033M	10mm	29mm	10mm	76mm

HELIX ANGLE = 22°

65-200B/ 65-300B



NEW

Two & Four Flute - High Finish Ballnose for Plastics

The tool's unique geometry, specially designed point, and highly polished primary clearance and flute give the tool the ability to attain a surface finish of 28 Ra in mechanical plastic.

Usage Plastic

Material SP See Selection Guide - pg. 2 - 12

TWO FLUTE

Part Number	Cutting DIA	Flute LGTH	SHK DIA	OAL	Flutes
65-205B	1/16	1/4	1/8	2	2
65-210B	1/8	1/2	1/8	2-1/2	2
65-215B	3/16	1/2	1/4	2-1/2	2
65-220B	1/4	1/2	1/4	2-1/2	2
65-225B	1/4	1-1/8	1/4	3	2
65-235B	5/16	1/2	5/16	3	2
65-240B	5/16	1-1/8	5/16	3	2
65-250B	3/8	1-1/8	3/8	3	2
65-260B	1/2	1-1/8	1/2	3	2

TWO FLUTE METRIC

Part Number	Cutting DIA	Flute LGTH	SHK DIA	OAL	Flutes
65-280B	3mm	12mm	3mm	64mm	2
65-285B	6mm	20mm	6mm	76mm	2
65-290B	8mm	25mm	8mm	76mm	2
65-295B	10mm	30mm	10mm	76mm	2

FOUR FLUTE

Part Number	Cutting DIA	Flute LGTH	SHK DIA	OAL	Flutes
65-310B	1/4	1/2	1/4	3	4
65-315B	5/16	1/2	5/16	3	4
65-320B	3/8	5/8	3/8	3	4
65-325B	1/2	3/4	1/2	3	4

Solid Carbide Edge Rounding

Designed for rounding the edge of sheets or parts. They come in both single flute and double flute.

Usage Edge rounding of parts

Material    See Selection Guide - pg. 2 - 12

SINGLE FLUTE STRAIGHT O-FLUTE

Part Number	Cutting DIA	Flute LGTH	SHK DIA	OAL	Opening	Radius	Small Flute LGTH	Tip To RAD	Plastic Size
66-082	1/4	3/8	1/4	2-1/2	5/32	1/8	.195	1/16	1/8
66-083	1/4	3/8	1/4	2-1/2	7/32	3/16	.180	1/16	3/16
66-084	1/4	3/8	1/4	2-1/2	9/32	1/4	.163	1/16	1/4

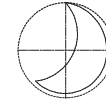

SINGLE FLUTE SPIRAL O-FLUTE

Part Number	Cutting DIA	Flute LGTH	SHK DIA	OAL	Opening	Radius	Small Flute LGTH	Tip To RAD	Plastic Size
66-085	1/4	3/8	1/4	2-1/2	5/32	1/8	.195	1/16	1/8
66-086	1/4	3/8	1/4	2-1/2	7/32	3/16	.180	1/16	3/16
66-087	1/4	3/8	1/4	2-1/2	9/32	1/4	.163	1/16	1/4

HELIX ANGLE = 22°

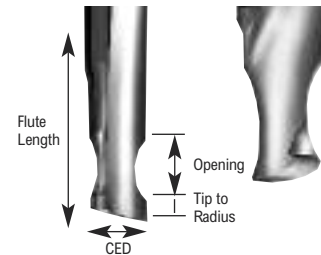

DOUBLE FLUTE STRAIGHT O-FLUTE

Part Number	Cutting DIA	Flute LGTH	SHK DIA	OAL	Opening	Radius	Small Flute LGTH	Tip To RAD	Plastic Size
66-092	1/4	3/8	1/4	2-1/2	5/32	1/8	.195	1/16	1/8
66-093	1/4	3/8	1/4	2-1/2	7/32	3/16	.180	1/16	3/16
66-094	1/4	3/8	1/4	2-1/2	9/32	1/4	.163	1/16	1/4

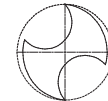

DOUBLE FLUTE STRAIGHT V-FLUTE

Part Number	Cutting DIA	Flute LGTH	SHK DIA	OAL	Opening	Radius	Small Flute LGTH	Tip To RAD	Plastic Size
66-120	3/8	3/8	3/8	2-1/2	5/32	1/8	.320	1/16	1/8
66-121	3/8	3/8	3/8	2-1/2	7/32	3/16	.305	1/16	3/16
66-122	3/8	3/8	3/8	2-1/2	9/32	1/4	.288	1/16	1/4
66-123	3/8	1/2	3/8	2-1/2	13/32	3/8	.255	1/16	3/8
66-160	1/2	3/8	1/2	3	5/32	1/8	.445	1/16	1/8
66-161	1/2	3/8	1/2	3	7/32	3/16	.430	1/16	3/16
66-162	1/2	3/8	1/2	3	9/32	1/4	.413	1/16	1/4
66-163	1/2	5/8	1/2	3	17/32	1/2	.347	1/16	1/2

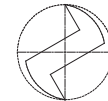

66-200



Double Flute - Solid Carbide Rout and Chamfer

Designed to provide up to a 1/16" top face chamfer and a finished side edge on plastic sheets or parts.

Usage Rout and chamfer in plastic

Material **SP** **HP** See Selection Guide - pg. 2 - 12

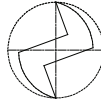

Part Number	Cutting DIA	Flute LGTH	SHK DIA	OAL	Material Thickness
66-200	1/4	3/16	3/8	2-1/4	1/8
66-204	1/4	1/4	3/8	2-1/4	3/16
66-210	3/8	5/16	1/2	3	1/4

HELIX ANGLE ≈ 0°

66-300



Double Flute - Solid Carbide Upcut Bottom Surfacing

Designed for pocketing applications where the bottom of the pocket must be smooth.

Usage Bottom surfacing for plastic and aluminum

Material **SP** **HP** See Selection Guide - pg. 2 - 12

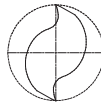

Part Number	Cutting DIA	Corner Radius	Flute LGTH	SHK DIA	OAL
66-308	1/8	.020	1/4	1/4	2
66-309	1/8	.002	1/4	1/4	2
66-314	1/4	.030	3/8	1/4	2
66-315	1/4	.002	3/8	1/4	2
66-320	3/8	.030	5/8	3/8	2-1/2
66-321	3/8	.002	5/8	3/8	2-1/2
66-326	1/2	.030	7/8	1/2	3
66-327	1/2	.002	7/8	1/2	3
66-328	3/4	.040	1-1/8	3/4	4

HELIX ANGLE ≈ 30°

66-800



NEW

DFC Compression for Composites (Coated)

The diamond film coated (CVD) solid carbide compression routers unique geometry prevents delamination on top and the bottom edges of the composites. The open flute geometry dissipates heat to prevent resin flow.

Usage Composite

Material **CP** See Selection Guide - pg. 2 - 12

Part Number	Cutting DIA	Flute LGTH	Upcut LGTH	SHK DIA	OAL	Flutes
66-802DFC	1/4	3/4	.325	1/4	3-1/2	4
66-811DFC*	3/8	1	.100	3/8	4	4
66-814DFC	3/8	1	.340	3/8	4	6
66-817DFC*	1/2	1-1/8	.100	1/2	4	6
66-823DFC	1/2	1-1/8	.350	1/2	4	6

*DOWNCUT EDGE TO WITHIN .050" OF TOOL END

METRIC

Part Number	Cutting DIA	Flute LGTH	Upcut LGTH	SHK DIA	OAL	Flutes
66-852DFC	6mm	20mm	7.75mm	6mm	90mm	4
66-858DFC	8mm	25mm	8mm	8mm	100mm	4
66-864DFC	10mm	25mm	8.5mm	10mm	100mm	6
66-870DFC	12mm	25mm	9mm	12mm	100mm	6

High Performance Composite Router (Coated)

The new High Performance Composite Router is designed for more efficient routing of composite materials, in both hand-fed and in CNC applications. Coated with AlTiN for increased tool life.

Usage Composites and fiberglass

Material  See Selection Guide - pg. 2 - 12

Part Number	Point Style	Cutting DIA	Flute LGTH	SHK DIA	OAL
66-901ALTIN	No	1/8	1/2	1/8	1-1/2
66-902ALTIN	BURR	1/8	1/2	1/8	1-1/2
66-903ALTIN	Endmill	1/8	1/2	1/8	1-1/2
66-904ALTIN	Drill	1/8	1/2	1/8	1-1/2
66-905ALTIN	No	3/16	5/8	1/4	2
66-906ALTIN	BURR	3/16	5/8	1/4	2
66-907ALTIN	Endmill	3/16	5/8	1/4	2
66-908ALTIN	Drill	3/16	5/8	1/4	2
66-909ALTIN	No	1/4	1	1/4	3
66-910ALTIN	BURR	1/4	1	1/4	3
66-911ALTIN	Endmill	1/4	1	1/4	3
66-912ALTIN	Drill	1/4	1	1/4	3
66-913ALTIN	No	1/4	1-1/2	1/4	3-1/2
66-914ALTIN	BURR	1/4	1-1/2	1/4	3-1/2
66-915ALTIN	Endmill	1/4	1-1/2	1/4	3-1/2
66-916ALTIN	Drill	1/4	1-1/2	1/4	3-1/2
66-917ALTIN	No	1/4	2-1/8	1/4	4
66-918ALTIN	BURR	1/4	2-1/8	1/4	4
66-919ALTIN	Endmill	1/4	2-1/8	1/4	4
66-920ALTIN	Drill	1/4	2-1/8	1/4	4
66-921ALTIN	No	3/8	1	3/8	3
66-922ALTIN	BURR	3/8	1	3/8	3
66-923ALTIN	Endmill	3/8	1	3/8	3
66-924ALTIN	Drill	3/8	1	3/8	3
66-925ALTIN	No	3/8	1-5/8	3/8	3-1/2
66-926ALTIN	BURR	3/8	1-5/8	3/8	3-1/2
66-927ALTIN	Endmill	3/8	1-5/8	3/8	3-1/2
66-928ALTIN	Drill	3/8	1-5/8	3/8	3-1/2
66-929ALTIN	No	3/8	2-1/8	3/8	4
66-930ALTIN	BURR	3/8	2-1/8	3/8	4
66-931ALTIN	Endmill	3/8	2-1/8	3/8	4
66-932ALTIN	Drill	3/8	2-1/8	3/8	4
66-933ALTIN	No	1/2	1-1/8	1/2	3
66-934ALTIN	BURR	1/2	1-1/8	1/2	3
66-935ALTIN	Endmill	1/2	1-1/8	1/2	3
66-936ALTIN	Drill	1/2	1-1/8	1/2	3
66-937ALTIN	No	1/2	1-5/8	1/2	4
66-938ALTIN	BURR	1/2	1-5/8	1/2	4

Part Number	Point Style	Cutting DIA	Flute LGTH	SHK DIA	OAL
66-939ALTIN	Endmill	1/2	1-5/8	1/2	4
66-940ALTIN	Drill	1/2	1-5/8	1/2	4
66-941ALTIN	No	1/2	2-1/8	1/2	4
66-942ALTIN	BURR	1/2	2-1/8	1/2	4
66-943ALTIN	Endmill	1/2	2-1/8	1/2	4
66-944ALTIN	Drill	1/2	2-1/8	1/2	4
66-945ALTIN	No	1/2	3-1/8	1/2	5
66-946ALTIN	BURR	1/2	3-1/8	1/2	5
66-947ALTIN	Endmill	1/2	3-1/8	1/2	5
66-948ALTIN	Drill	1/2	3-1/8	1/2	5
66-949ALTIN	No	1/2	4-1/8	1/2	6
66-950ALTIN	BURR	1/2	4-1/8	1/2	6
66-951ALTIN	Endmill	1/2	4-1/8	1/2	6
66-952ALTIN	Drill	1/2	4-1/8	1/2	6
66-971ALTIN	No	4mm	16mm	6mm	50mm
66-972ALTIN	BURR	4mm	16mm	6mm	50mm
66-973ALTIN	Endmill	4mm	16mm	6mm	50mm
66-974ALTIN	Drill	4mm	16mm	6mm	50mm
66-975ALTIN	No	6mm	19mm	6mm	75mm
66-976ALTIN	BURR	6mm	19mm	6mm	75mm
66-977ALTIN	Endmill	6mm	19mm	6mm	75mm
66-978ALTIN	Drill	6mm	19mm	6mm	75mm
66-979ALTIN	No	6mm	25mm	6mm	75mm
66-980ALTIN	BURR	6mm	25mm	6mm	75mm
66-981ALTIN	Endmill	6mm	25mm	6mm	75mm
66-982ALTIN	Drill	6mm	25mm	6mm	75mm
66-983ALTIN	No	8mm	25mm	8mm	63mm
66-984ALTIN	BURR	8mm	25mm	8mm	63mm
66-985ALTIN	Endmill	8mm	25mm	8mm	63mm
66-986ALTIN	Drill	8mm	25mm	8mm	63mm
66-987ALTIN	No	10mm	25mm	10mm	75mm
66-988ALTIN	BURR	10mm	25mm	10mm	75mm
66-989ALTIN	Endmill	10mm	25mm	10mm	75mm
66-990ALTIN	Drill	10mm	25mm	10mm	75mm
66-991ALTIN	No	12mm	25mm	12mm	75mm
66-992ALTIN	BURR	12mm	25mm	12mm	75mm
66-993ALTIN	Endmill	12mm	25mm	12mm	75mm
66-994ALTIN	Drill	12mm	25mm	12mm	75mm



NEW

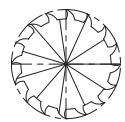

Burr Point



Drill Point

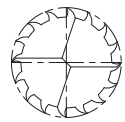

End Mill Point



No Point

67-000
67-250



Solid Carbide Fiberglass Router

Designed as fiberglass routers. Their upcut/downcut diamond design effectively shears fibrous materials. Certain tools in the line have been further developed to cut aramid fiber composites.

Usage Fiberglass and composites

Material  See Selection Guide - pg. 2 - 12

MEDIUM BURR W/END MILL POINT

Part Number	Cutting DIA	Flute LGTH	SHK DIA	OAL
67-003	1/8	1	1/8	2
67-010	1/4	3/4	1/4	2-1/2
67-011	1/4	1-1/8	1/4	3
67-012	1/4	1-1/4	1/4	3
67-014	1/4	1-1/2	1/4	3
67-017	1/4	2-1/8	1/4	4
67-030	3/8	7/8	3/8	2-1/2

MEDIUM BURR W/END MILL POINT

Part Number	Cutting DIA	Flute LGTH	SHK DIA	OAL
67-023	3/8	1-5/8	3/8	3
67-027	3/8	2-1/8	3/8	4
67-031	1/2	1-1/8	1/2	3
67-033	1/2	1-5/8	1/2	4
67-037	1/2	2-1/8	1/2	4
67-039	1/2	3-1/8	1/2	5
67-065	3/4	4-1/8	3/4	6

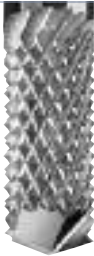

MEDIUM BURR W/DRILL POINT

Part Number	Cutting DIA	Flute LGTH	SHK DIA	OAL
67-080	1/4	3/4	1/4	2-1/2
67-120	3/8	7/8	3/8	2-1/2
67-160	1/2	1	1/2	3



3 FLUTE DOWNCUT DIAMOND GRIT TOOL

Part Number	Cutting DIA	Flute LGTH	SHK DIA	OAL
67-254	1/4	1-1/8	1/4	3

3 FLUTE DOWNCUT DIAMOND GRIT TOOL

Part Number	Cutting DIA	Flute LGTH	SHK DIA	OAL
67-256	1/4	1-3/8	1/4	3
67-258	3/8	1-3/8	3/8	3

67-200



Three Flute - Solid Carbide Phenolic Cutter

Equally adaptable to low or high spindle speed applications in any CNC machining environment. The free cutting action of the tools provides for better finishes and significantly lower noise levels.

Usage Phenolic

Material  See Selection Guide - pg. 2 - 12

UPCUT

Part Number	Cutting DIA	Flute LGTH	SHK DIA	OAL
67-205	3/8	7/8	3/8	3
67-211	1/2	1-1/8	1/2	3
67-215	1/2	2-1/8	1/2	4

DOWNCUT

Part Number	Cutting DIA	Flute LGTH	SHK DIA	OAL
67-206	3/8	7/8	3/8	3
67-212	1/2	1-1/8	1/2	3-1/2
67-216	1/2	2-1/8	1/2	4-1/2

HELIX ANGLE ≈ 10°

METRIC

Part Number	Cutting DIA	Flute LGTH	SHK DIA	OAL
67-207	10mm	22mm	10mm	75mm
67-209	12mm	28mm	12mm	75mm

METRIC

Part Number	Cutting DIA	Flute LGTH	SHK DIA	OAL
67-208	10mm	22mm	10mm	75mm
67-210	12mm	28mm	12mm	75mm

Three Flute - PCD Progressive Chipbreaker for Composites

Provides superior chip control and increased tool life when cutting dense and abrasive materials. The new chipbreaker incorporates a unique geometry with a PCD cutting edge to support a wide range of feed rates and depth of cut combinations while extending the life of the tool. This is accomplished by utilizing a distinct Hi-Low asymmetrical chipbreaker profile which reduces vibration and chatter, caused by harmonic imbalance, resulting in improved surface finishes, while reducing noise levels and wear on the tool.

Usage Composites and phenolic

Material  See Selection Guide - pg. 2 - 12

Part Number	Cutting DIA	Flute LGTH	SHK DIA	OAL
67-221	3/8	3/8	3/8	3
67-225	1/2	5/8	1/2	3
67-227	1/2	1-1/8	1/2	3

METRIC

Part Number	Cutting DIA	Flute LGTH	SHK DIA	OAL
67-230	10mm	12mm	10mm	76mm
67-233	12mm	20mm	12mm	100mm

67-220



NEW

Double Flute - Solid Carbide Compression Spiral

Compression design for fast feed and excellent finish on both sides of the material.

Usage Composite panels and honeycomb core

Material  See Selection Guide - pg. 2 - 12

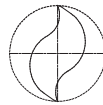

Part Number	Cutting DIA	Flute LGTH	SHK DIA	OAL	Diamond Coated Part Number
67-305	1/4	7/8	1/4	2-1/2	-
67-314	3/8	1-1/8	3/8	3	67-314DFC
67-320*	1/2	7/8	1/2	3	-
67-322	1/2	1-1/8	1/2	3	67-322DFC

* = Mortise Compression

HELIX ANGLE = 30°

67-300



Solid Carbide Un-Ruffer™ PATENTED

The unique design allows for the cutting performance of a burr while achieving a good surface finish.

Usage Composite panels

Material  See Selection Guide - pg. 2 - 12

METRIC

Part Number	Cutting DIA	Flute LGTH	SHK DIA	OAL
67-426M	6mm	25mm	6mm	64mm
67-435M	10mm	25mm	10mm	76mm
67-445M	12mm	25mm	12mm	76mm

Part Number	Cutting DIA	Flute LGTH	SHK DIA	OAL
67-423	1/4	3/4	1/4	2
67-426	1/4	1	1/4	2-1/2
67-428	1/4	1	1/4	3
67-435	3/8	1	3/8	3
67-445	1/2	1	1/2	3

67-400



Solid Carbide CG Tool (Carbon Graphite)

The geometry of these tools increases the amount of effective cutting flutes resulting in superior performance over a standard burr.

Usage Carbon graphite and carbon fiber panels

Material  See Selection Guide - pg. 2 - 12

Part Number	Cutting DIA	Flute LGTH	SHK DIA	OAL
67-505	1/8	1/2	1/8	2
67-508	3/16	5/8	3/16	2
67-511	1/4	3/4	1/4	3
67-514	1/4	1-1/2	1/4	3
67-520	3/8	1-1/8	3/8	3-1/2
67-523	1/2	1-1/8	1/2	3-1/2
67-526	1/2	2-1/8	1/2	4

67-500



Solid Carbide 8 Facet Drill



Designed to reduce cutting forces and eliminating delamination when exiting the material.

Usage Composites, Carbon fiber, mechanical plastics, and fiber reinforced plastics

What is an 8 Facet Drill?

An 8 facet drill consists of 4 cutting edges with 2 facets per cutting edge. These facets consist of the lip relief and the lip clearance angle.

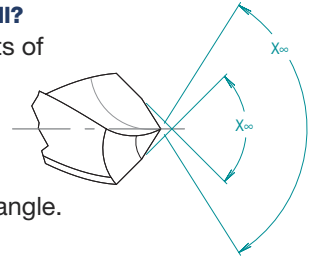

FRACTIONAL DRILLS

Part Number	Cutting DIA	Flute LGTH	SHK DIA	OAL
67-807	1/8 (0.1250)	1-1/4	0.125	2-1/4
67-808	9/64 (0.1406)	1-3/8	0.140	2-1/2
67-809	5/32 (0.1563)	1-3/8	0.156	2-1/2
67-810	11/64 (0.1719)	1-5/8	0.172	2-3/4
67-811	3/16 (0.1875)	1-5/8	0.188	2-3/4
67-812	13/64 (0.2013)	1-3/4	0.203	3
67-813	7/32 (0.2188)	1-3/4	0.219	3
67-814	15/64 (0.2344)	2	0.234	3-1/4
67-815	1/4 (0.2500)	2	0.250	3-1/4
67-816	17/64 (0.2656)	2-1/8	0.266	3-1/2
67-817	9/32 (0.2813)	2-1/8	0.281	3-1/2
67-818	19/64 (0.2969)	2-3/8	0.297	3-3/4
67-819	5/16 (0.3125)	2-3/8	0.313	3-3/4
67-820	21/64 (0.3281)	2-1/2	0.328	4
67-821	11/32 (0.3438)	2-1/2	0.344	4
67-822	23/64 (0.3594)	2-1/2	0.359	4
67-823	3/8 (0.3750)	2-3/4	0.375	4-1/4
67-824	25/64 (0.3906)	2-7/8	0.391	4-1/2
67-825	13/32 (0.4063)	2-7/8	0.406	4-1/2
67-826	27/64 (0.4219)	2-7/8	0.422	4-1/2
67-827	7/16 (0.4375)	2-7/8	0.438	4-1/2
67-828	29/64 (0.4531)	3	0.453	4-3/4
67-829	15/32 (0.4688)	3	0.469	4-3/4
67-830	31/64 (0.4844)	3	0.484	4-3/4
67-831	1/2 (0.5000)	3	0.500	4-3/4

LETTER DRILLS (CONT.)

Part Number	Cutting DIA	Flute LGTH	SHK DIA	OAL
67-850	A (0.2340)	2	0.234	3-1/4
67-851	B (0.2380)	2	0.238	3-1/4
67-852	C (0.2420)	2	0.242	3-1/4
67-853	D (0.2460)	2	0.246	3-1/4
67-854	E (0.2500)	2	0.250	3-1/4
67-855	F (0.2570)	2	0.257	3-1/4
67-856	G (0.2610)	2-1/8	0.261	3-1/2
67-857	H (0.2660)	2-1/8	0.266	3-1/2
67-858	I (0.2720)	2-1/8	0.272	3-1/2

LETTER DRILLS (CONT.)

Part Number	Cutting DIA	Flute LGTH	SHK DIA	OAL
67-859	J (0.2770)	2-1/8	0.277	3-1/2
67-860	K (0.2810)	2-1/8	0.281	3-1/2
67-861	L (0.2910)	2-1/8	0.291	3-1/2
67-862	M (0.2950)	2-3/8	0.295	3-3/4
67-863	N (0.3020)	2-3/8	0.302	3-3/4
67-864	O (0.3160)	2-3/8	0.316	3-3/4
67-865	P (0.3230)	2-3/8	0.323	3-3/4
67-866	Q (0.3320)	2-1/2	0.332	4
67-867	R (0.3390)	2-1/2	0.339	4
67-868	S (0.3480)	2-1/2	0.348	4
67-869	T (0.3580)	2-1/2	0.358	4
67-870	U (0.3680)	2-3/4	0.368	4-1/4
67-871	V (0.3770)	2-3/4	0.377	4-1/4
67-872	W (0.3860)	2-7/8	0.386	4-1/2
67-873	X (0.3970)	2-7/8	0.397	4-1/2
67-874	Y (0.4040)	2-7/8	0.404	4-1/2
67-875	Z (0.4130)	2-7/8	0.413	4-1/2

NUMBER DRILLS

Part Number	Cutting DIA	Flute LGTH	SHK DIA	OAL
67-876	1 (0.2280)	1-3/4	0.228	3
67-877	2 (0.2210)	1-3/4	0.221	3
67-878	3 (0.2130)	1-3/4	0.213	3
67-879	4 (0.2090)	1-3/4	0.209	3
67-880	5 (0.2055)	1-3/4	0.206	3
67-881	6 (0.2040)	1-3/4	0.204	3
67-882	7 (0.2010)	1-3/4	0.201	3
67-883	8 (0.1990)	1-3/4	0.199	3
67-884	9 (0.1960)	1-3/4	0.196	3
67-885	10 (0.1935)	1-5/8	0.194	2-3/4
67-886	11 (0.1910)	1-5/8	0.191	2-3/4
67-887	12 (0.1890)	1-5/8	0.189	2-3/4
67-888	13 (0.1850)	1-5/8	0.185	2-3/4
67-889	14 (0.1820)	1-5/8	0.182	2-3/4
67-890	15 (0.1800)	1-5/8	0.180	2-3/4
67-891	16 (0.1770)	1-5/8	0.177	2-3/4
67-892	17 (0.1730)	1-5/8	0.173	2-3/4

NUMBER DRILLS (CONT.)

Part Number	Cutting DIA	Flute LGTH	SHK DIA	OAL
67-893	18 (0.1695)	1-5/8	0.170	2-3/4
67-894	19 (0.1660)	1-5/8	0.166	2-3/4
67-895	20 (0.1610)	1-3/8	0.161	2-1/2
67-896	21 (0.1590)	1-3/8	0.159	2-1/2
67-897	22 (0.1570)	1-3/8	0.157	2-1/2
67-898	23 (0.1540)	1-3/8	0.154	2-1/2
67-899	24 (0.1520)	1-3/8	0.152	2-1/2
67-900	25 (0.1495)	1-3/8	0.150	2-1/2
67-901	26 (0.1470)	1-3/8	0.147	2-1/2
67-902	27 (0.1440)	1-3/8	0.144	2-1/2
67-903	28 (0.1405)	1-3/8	0.141	2-1/2
67-904	29 (0.1360)	1-3/8	0.136	2-1/2
67-905	30 (0.1285)	1-1/4	0.129	2-1/4
67-906	31 (0.1200)	1-1/4	0.120	2-1/4

METRIC DRILLS

Part Number	Cutting DIA	Flute LGTH	SHK DIA	OAL
67-961	3.00 (0.1181)	32	3.00	57
67-962	3.50 (0.1378)	35	3.50	64
67-963	4.00 (0.1575)	35	4.00	64
67-964	4.50 (0.1772)	41	4.50	70
67-965	5.00 (0.1969)	44	5.00	76
67-966	5.50 (0.2165)	44	5.50	76
67-967	6.00 (0.2362)	51	6.00	83
67-968	6.50 (0.2559)	51	6.50	83
67-969	7.00 (0.2756)	57	7.00	89
67-970	7.50 (0.2953)	60	7.50	95
67-971	8.00 (0.3150)	60	8.00	95
67-972	8.50 (0.3346)	64	8.50	102
67-973	9.00 (0.3543)	64	9.00	102
67-974	9.50 (0.3740)	70	9.50	108
67-975	10.00 (0.3937)	73	10.00	114
67-976	10.50 (0.4134)	73	10.50	114
67-977	11.00 (0.4331)	73	11.00	114
67-978	11.50 (0.4528)	76	11.50	121
67-979	12.00 (0.4724)	76	12.00	121

Double Flute - PCD Tipped Tooling

Designed for use in abrasive materials where cut quality and tool life are important.

Usage Composite panels and fiberglass

Material  See Selection Guide - pg. 2 - 12



PCD Tipped



PCD Full Face with Plunge Point

PCD FULL FACE

Part Number	Cutting DIA	Flute LGTH	SHK DIA	OAL
68-005	1/4	3/4	1/4	3
68-010	3/8	3/4	3/8	3
68-020	1/2	3/4	1/2	4
68-030	3/4	1	3/4	4

HELIX ANGLE ≈ 0-3°

PCD FULL FACE with PLUNGE POINT

Part Number	Cutting DIA	Flute LGTH	SHK DIA	OAL
68-050	1/4	3/4	1/4	3
68-055	3/8	7/8	3/8	3
68-062	1/2	1-1/4	1/2	4
68-070	3/4	1-1/4	3/4	4
68-072	3/4	1-1/4	3/4	4

Down Shear



Single Flute - PCD Compression Tool

This economical PCD compression tool will provide long tool life in abrasive wood products. Mortise tip allowing for through cuts and dado's to be produced using one tool. The compression design ensures chip free edges on the top and bottom.

Usage Composite wood

Material  See Selection Guide - pg. 2 - 12

Part Number	Cutting DIA	Flute LGTH	Upcut Flute LGTH	SHK DIA	OAL	Flutes
68-101	3/8	1	0.188	3/8	3	1
68-101L	3/8	1	0.188	3/8	3	1
68-100	3/8	1	0.188	1/2	3	1
68-100L	3/8	1	0.188	1/2	3	1
68-102	1/2	1	0.200	1/2	3	1
68-102L	1/2	1	0.200	1/2	3	1
68-103	1/2	1-1/4	0.200	1/2	3	1
68-104	5/8	1	0.200	5/8	3-1/2	1

Part Number	Cutting DIA	Flute LGTH	Upcut Flute LGTH	SHK DIA	OAL	Flutes
68-104L*	5/8	1	0.200	5/8	3-1/2	1
68-110	5/8	1-5/8	0.200	5/8	4	1
68-110L*	5/8	1-5/8	0.200	5/8	4	1
68-106	3/4	1	0.200	3/4	4	1
68-106L*	3/4	1	0.200	3/4	4	1
68-112	3/4	1-5/8	0.200	3/4	4	1
68-112L*	3/4	1-5/8	0.200	3/4	4	1

L = Left Hand Rotation

* = Tools are not stocked and must be special ordered. Approx. 4 week lead time.



68-200



Double Flute - PCD SERF™ Cutter

This tool is designed to act like a rougher and finishing tool in one. The unique geometry reduces the cutting forces resulting in longer tool life, higher feed rates and reduced noise.

Usage Composites

Material  See Selection Guide - pg. 2 - 12

METRIC

Part Number	Cutting DIA	Flute LGTH	SHK DIA	OAL
68-213M	6mm	20mm	6mm	76mm
68-226M	10mm	25mm	10mm	88mm
68-236M	12mm	32mm	12mm	100mm

Part Number	Cutting DIA	Flute LGTH	SHK DIA	OAL
68-210	1/4	3/8	1/4	3
68-213	1/4	3/4	1/4	3
68-216	1/4	1	1/4	3-1/2
68-220	3/8	3/8	3/8	3
68-223	3/8	3/4	3/8	3
68-226	3/8	1	3/8	3-1/2
68-230	1/2	3/4	1/2	4
68-233	1/2	1	1/2	4
68-236	1/2	1-1/4	1/2	4

68-300



Three Flute - PCD SERFIN™ Cutter

Three-Flute tool with two roughing edges that have geometry to reduce cutting forces and shear fibers in high-strength composite and other fiber reinforced plastic materials. The finishing edge cleans up after roughing cuts to create a smooth edge on material.

Usage Composites

Material  See Selection Guide - pg. 2 - 12

Part Number	Cutting DIA	Flute LGTH	SHK DIA	OAL
68-315	3/8	1/2	3/8	4
68-320	3/8	7/8	3/8	4
68-340	1/2	5/8	1/2	4
68-345	1/2	1	1/2	4
68-350	1/2	1-1/4	1/2	4
68-360	3/4	1-3/8	3/4	5

METRIC

Part Number	Cutting DIA	Flute LGTH	SHK DIA	OAL
68-310	8mm	10mm	8mm	76mm
68-325	10mm	14mm	10mm	100mm
68-330	12mm	14mm	12mm	100mm
68-335	12mm	26mm	12mm	100mm
68-355	16mm	26mm	16mm	100mm

NEW

68-400



Double Flute - PCD Ballnose

Designed for use in abrasive materials where cut quality and tool life are important.

Usage Composites

Part Number	Cutting DIA	Flute LGTH	SHK DIA	OAL
68-405	1/4	3/8	1/4	2-1/2
68-410	3/8	1/2	3/8	3
68-420	1/2	5/8	1/2	4
68-425	5/8	7/8	5/8	4
68-430	3/4	1	3/4	4

METRIC

Part Number	Cutting DIA	Flute LGTH	SHK DIA	OAL
68-440	6mm	10mm	6mm	76mm
68-445	8mm	10mm	8mm	76mm
68-450	10mm	12mm	10mm	76mm
68-455	12mm	20mm	12mm	100mm

NEW

PCD 8 Facet Drills

The PCD 8 facet drill works well in composite material where long tool life and a delamination free hole is required. The drill diameters are oversized allowing for aircraft fasteners to extend through the holes.

Usage Composites

Material  See Selection Guide - pg. 2 - 12

What is an 8 Facet Drill?

An 8 facet drill consists of 4 cutting edges with 2 facets per cutting edge. These facets consist of the lip relief and the lip clearance angle.

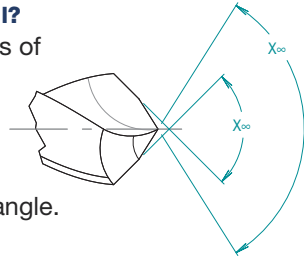

Part Number	Cutting DIA	Flute LGTH	SHK DIA	OAL
68-902	0.100	1	1/4	3
68-904	0.129	1	1/4	3
68-908	0.147	1	1/4	3
68-910	0.192	1	1/4	3
68-914	0.251	1	1/4	3
68-918	0.313	1	5/16	3
68-922	0.376	1	3/8	3
68-926	0.502	1	1/2	3

68-900



Carbide Tipped Trim Blade and Arbor

Designed to trim and groove both hard and soft plastics. These blades run in conjunction with the blade arbors. Blades are reversible for right or left hand rotation cutting.

Usage Hard and soft plastic

Material   See Selection Guide - pg. 2 - 12

SOFT PLASTIC - SLOW FEED

Part Number	Cutting DIA	Teeth	Rake	Kerf	Grind
70-100	2	10	0°	.095	TCG
70-102	2-1/2	10	0°	.095	TCG
70-104	3	10	0°	.095	TCG
70-108	4	10	0°	.095	TCG

HARD PLASTIC - FAST FEED

Part Number	Cutting DIA	Teeth	Rake	Kerf	Grind
70-160	2	16	-5°	.095	TCG
70-162	2-1/2	20	-5°	.095	TCG
70-164	3	20	-5°	.095	TCG
70-166	3-1/2	20	-5°	.095	TCG
70-168	4	20	-5°	.095	TCG

TCG = Triple Chip Grind

SOFT PLASTIC - FAST FEED

Part Number	Cutting DIA	Teeth	Rake	Kerf	Grind
70-120	2	16	0°	.095	TCG
70-122	2-1/2	20	0°	.095	TCG
70-124	3	20	0°	.095	TCG
70-126	3-1/2	20	0°	.095	TCG
70-128	4	20	0°	.095	TCG

SAW ARBOR - These saw arbors are designed to hold the carbide tipped saws.

Part Number	Cutting DIA	OAL
70-180	1/2	3-1/4
70-181	1/2	4-1/2

*SEE FEED & SPEED CHART ON PAGE 59.

70-100



70-200



Solid Carbide Trim Blade Flush Mount

These small diameter solid carbide arbor mounted blades are designed for trimming and slotting plastics. Blades are permanently attached to arbors and are not reversible.

Usage Hard and soft plastic

Material **SP** **HP**

See Selection Guide - pg. 2 - 12

Part Number	Cutting DIA	Collar	SHK DIA	Kerf	OAL	Rotation
70-204	1	9/16	1/2	.062	4	Right
70-224	1-1/4	5/8	1/2	.062	4	Right

*SEE FEED & SPEED CHART ON PAGE 59.

70-300

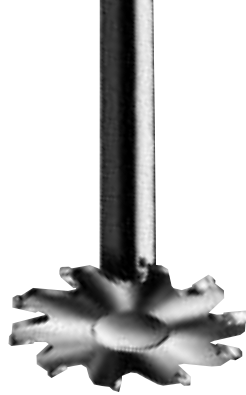

Carbide Tipped Trim Blade Flush Mount

Designed for flush trimming and slotting of both hard and soft plastics. Blades are permanently attached to arbors and are not reversible.

Usage Hard and soft plastic

Material **SP** **HP** See Selection Guide - pg. 2 - 12

Part Number	Cutting DIA	Teeth	Rake	SHK DIA	Kerf	OAL	Grind	Rotation	Plastic	Feed
70-300	2	10	0°	1/2	.095	4	TCG	RH	Soft	Slow
70-302	2	10	0°	1/2	.095	4	TCG	LH	Soft	Slow
70-320	2	16	0°	1/2	.095	4	TCG	RH	Soft	Fast
70-322	2	16	0°	1/2	.095	4	TCG	LH	Soft	Fast
70-340	2	10	-5°	1/2	.095	4	TCG	RH	Hard	Slow
70-342	2	10	-5°	1/2	.095	4	TCG	LH	Hard	Slow
70-360	2	16	-5°	1/2	.095	4	TCG	RH	Hard	Fast
70-362	2	16	-5°	1/2	.095	4	TCG	LH	Hard	Fast

*SEE FEED & SPEED CHART BELOW
TCG = Triple Chip Grind

Feeds & Speeds for Blades INCHES PER MINUTE

Tool Series	Cutting DIA	Max RPM	Soft Plastic	Hard Plastic	Fibrous Reinfrc
70-100	2"	18,000	150	150	150
70-100	2-1/2"	16,000	150	150	150
70-100	3"	14,000	150	150	150
70-100	3-1/2"	12,000	150	150	150
70-100	4"	10,000	150	150	150
70-200	1-1/2" & Smaller	14,000	150	150	150
70-300	2"	16,000	150	150	150

72-000



Through Hole **Brad Point**



Hinge

Solid Carbide Boring Bits

Two style of tools are available in this series. The brad point drill is designed to cut blind holes and produce a clean edge on the top surface. The 60° through drill is designed to produce through holes while providing clean edges on both sides.

Usage Wood

Material



See Selection Guide - pg. 2 - 12

BRAD POINT - designed to produce a blind hole while preventing fraying on the top edge.

THROUGH HOLE (60° POINT) - produces a through hole and reduces fraying on the entry and exit edges.

RIGHT HAND ROTATION

Part Number	Cutting DIA	SHK DIA	OAL	Part Number	Cutting DIA	SHK DIA	OAL
72-001	3	10	57	72-021	3	10	70
72-005	5	10	57	72-025	5	10	70
72-009	6	10	57	72-029	6	10	70
72-013	8	10	57	72-033	8	10	70

RIGHT HAND ROTATION

Part Number	Cutting DIA	SHK DIA	OAL	Part Number	Cutting DIA	SHK DIA	OAL
72-053	3	10	57	72-075	3	10	70
72-057	5	10	57	72-079	5	10	70
72-061	6	10	57	72-083	6	10	70
72-065	8	10	57	72-087	8	10	70

LEFT HAND ROTATION

Part Number	Cutting DIA	SHK DIA	OAL	Part Number	Cutting DIA	SHK DIA	OAL
72-002	3	10	57	72-022	3	10	70
72-006	5	10	57	72-026	5	10	70
72-010	6	10	57	72-030	6	10	70
72-014	8	10	57	72-034	8	10	70

LEFT HAND ROTATION

Part Number	Cutting DIA	SHK DIA	OAL	Part Number	Cutting DIA	SHK DIA	OAL
72-054	3	10	57	72-076	3	10	70
72-058	5	10	57	72-080	5	10	70
72-062	6	10	57	72-084	6	10	70
72-066	8	10	57	72-088	8	10	70

HINGE BIT - This 35mm carbide tipped bit is designed to produce a flat bottom hole with clean edges for hinge mounting.

Part Number	Cutting DIA	SHK DIA	OAL
72-097	35	10	70

77-100

Double or Three Flute Solid Carbide Taper Tools

The taper tools are available with a variety of taper angles and come standard with a ball nose point. The tools are designed to produce a good edge finish in a wide variety of materials.

Usage Wood, plastic and aluminum

Material **SW** **HW**
SP **HP** **A**
 See Selection Guide - pg. 2 - 12

Part Number	Cutting DIA	Flute LGTH	SHK DIA	OAL	Angle Per Side	Radius	Flutes
77-102	1/8	1-1/2	1/4	3	1°	1/16	3
77-104	1/8	1	1/4	3	3°	1/16	3
77-106	1/8	3/4	1/4	3	5°	1/16	3
77-108	1/8	1/2	1/4	3	7°	1/16	3
77-112	1/4	2	1/2	4	3°	1/8	2
77-114	1/4	1-3/8	1/2	4	5°	1/8	2
77-116	1/4	1	1/2	4	7°	1/8	2



METRIC

Part Number	Cutting DIA	Flute LGTH	SHK DIA	OAL	Angle Per Side	Radius	Flutes
77-102M	3mm	39mm	6mm	76mm	1°	1.5mm	3
77-104M	3mm	25mm	6mm	76mm	3°	1.5mm	3
77-106M	3mm	19mm	6mm	76mm	5°	1.5mm	3
77-108M	3mm	12mm	6mm	76mm	7°	1.5mm	3
77-112M	6mm	50mm	12mm	100mm	3°	3mm	2
77-114M	6mm	35mm	12mm	100mm	5°	3mm	2
77-116M	6mm	25mm	12mm	100mm	7°	3mm	2

Three Flute - High Speed Steel Taper Pin Router

These three flute upcuts with a tapered flute are used for profiling and trimming primarily in aircraft assembly operations.

Usage Aluminum

Material **A** See Selection Guide - pg. 2 - 12

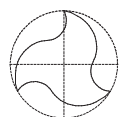

Part Number	Cutting DIA	Flute LGTH	SHK DIA	OAL
80-001	.098	3/4	.098	2
80-002	.110	7/8	.128	2 1/4
80-003	.165	1 1/16	.1875	2 1/2

HELIX ANGLE ≈ 24°

80-000



81-000



Double Flute - High Speed Steel Lo Helix

These lo helix upcut spirals were developed for CNC routers used primarily in the aircraft industry. They are designed with maximum strength of configuration to cut T, O or combined stacks of aluminum-using coolant.

Usage Aluminum

Material  See Selection Guide - pg. 2 - 12

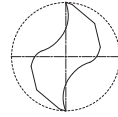

Part Number	Cutting DIA	Flute LGTH	SHK DIA	OAL	Helix	ALUM Condition
81-001	1/4	3/4	1/2	3 1/16	5°	T
81-003	5/16	3/4	1/2	3 1/16	10°	C
81-004	5/16	3/4	1/2	3 1/16	10°	O

81-100



Double Flute - Solid Carbide Spiral Extrusion Cutters

Designed for reduced vibration producing smoother finish cuts. Extended reach during side thinning and gage reduction. Longer tool life to reduce tool changes.

Usage Extrusion and sheet aluminum.
Optimized for use on multi-head extrusion mills CNC mills and routers

Material  See Selection Guide - pg. 2 - 12

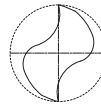

Part Number	Cutting DIA	Flute LGTH	ERL	SHK DIA	OAL	Helix & DIR	Flutes	CNR RAD Chamfer	Aluminum Condition	Machining Environment
Tolerance	+.002	±.03		+.0000 -.0005	±.03					
81-103	5/16	13/16	-	1/2	3	10°RH	2	.02 x 45°	C	Wet
81-104	3/8	13/16	-	1/2	3	10°RH	2	.02 x 45°	O	Wet

83-300



Double Flute - Solid Carbide AlTiN Coated Upcut Spiral for Stainless Steel

Special cutting geometry is required to cut stainless steel and achieve decent tool life. Onsrud has developed a line of cutters which are capable of cutting stainless steel.

Usage Stainless Steel

Material  See Selection Guide - pg. 2 - 12

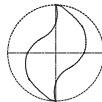

Part Number	Cutting DIA	Flute LGTH	SHK DIA	OAL
83-305AlTiN	1/8	1/4	1/8	2
83-310AlTiN	3/16	3/8	3/16	2-1/2
83-315AlTiN	1/4	3/8	1/4	2-1/2
83-320AlTiN	3/8	1/2	3/8	3

CUTTING PARAMETERS

Part Number	RPM	Feedrate	Depth of Cut
83-305AlTiN	18,000	18 IPM	.012
83-310AlTiN	12,000	20 IPM	.020
83-315AlTiN	9,000	25 IPM	.030
83-320AlTiN	6,010	27 IPM	.045

Solid Carbide CFRP Drill (Coated)

85-800

The CFRP drill is designed to ensure hole quality and diameter. The “W” point of the drill centers the drill to let the peripheral cutting edges shear the material producing a clean, tight tolerance hole without fraying or delamination. The drills are coated with a Diamond Like Carbon (DLC).

Usage Carbon Fiber Reinforced Plastics, Kevlar® and Composites

Material  See Selection Guide - pg. 2 - 12



NEW

FRACTIONAL DRILLS

Part Number	Cutting DIA	Flute LGTH	SHK DIA	OAL
85-807	1/8 (0.1250)	0.500	1/8	3
85-808	9/64 (0.1406)	0.500	3/16	3
85-809	5/32 (0.1563)	0.500	3/16	3
85-810	11/64 (0.1719)	0.500	3/16	3
85-811	3/16 (0.1875)	0.500	3/16	3
85-812	13/64 (0.2031)	0.500	1/4	3
85-813	7/32 (0.2188)	0.500	1/4	3
85-814	15/64 (0.2344)	0.500	1/4	3
85-815	1/4 (0.2500)	0.500	1/4	3
85-816	17/64 (0.2656)	0.500	5/16	3
85-817	9/32 (0.2813)	0.500	5/16	3
85-818	19/64 (0.2969)	0.500	5/16	3
85-819	5/16 (0.3125)	0.500	5/16	3
85-820	21/64 (0.3281)	0.500	3/8	3
85-821	11/32 (0.3438)	0.500	3/8	3
85-822	23/64 (0.3594)	0.500	3/8	3
85-823	3/8 (0.3750)	0.500	3/8	3
85-827	7/16 (0.4375)	0.500	7/16	3
85-831	1/2 (0.5000)	0.500	1/2	3

METRIC DRILLS

Part Number	Cutting DIA	Flute LGTH	SHK DIA	OAL
85-961	3.00 (0.1181)	12.000	3	76
85-963	4.00 (0.1575)	12.000	4	76
85-965	5.00 (0.1969)	12.000	5	76
85-967	6.00 (0.2362)	12.000	6	76
85-971	8.00 (0.3150)	12.000	8	76
85-975	10.00 (0.3937)	12.000	10	76
85-979	12.00 (0.4724)	12.000	12	76

NUMBER DRILLS

Part Number	Cutting DIA	Flute LGTH	SHK DIA	OAL
85-876	1 (0.2280)	0.500	1/4	3
85-877	2 (0.2210)	0.500	1/4	3
85-878	3 (0.2130)	0.500	1/4	3
85-879	4 (0.2090)	0.500	1/4	3
85-880	5 (0.2055)	0.500	1/4	3
85-881	6 (0.2040)	0.500	1/4	3
85-882	7 (0.2010)	0.500	1/4	3
85-883	8 (0.1990)	0.500	1/4	3
85-884	9 (0.1960)	0.500	1/4	3
85-885	10 (0.1935)	0.500	1/4	3
85-886	11 (0.1910)	0.500	1/4	3
85-887	12 (0.1890)	0.500	1/4	3
85-888	13 (0.1850)	0.500	3/16	3
85-889	14 (0.1820)	0.500	3/16	3
85-890	15 (0.1800)	0.500	3/16	3
85-891	16 (0.1770)	0.500	3/16	3
85-892	17 (0.1730)	0.500	3/16	3
85-893	18 (0.1695)	0.500	3/16	3
85-894	19 (0.1660)	0.500	3/16	3
85-895	20 (0.1610)	0.500	3/16	3
85-896	21 (0.1590)	0.500	3/16	3

NUMBER DRILLS (CONT.)

Part Number	Cutting DIA	Flute LGTH	SHK DIA	OAL
85-897	22 (0.1570)	0.500	3/16	3
85-898	23 (0.1540)	0.500	5/32	3
85-899	24 (0.1520)	0.500	5/32	3
85-900	25 (0.1495)	0.500	5/32	3
85-901	26 (0.1470)	0.500	5/32	3
85-902	27 (0.1440)	0.500	5/32	3
85-903	28 (0.1405)	0.500	5/32	3
85-904	29 (0.1360)	0.500	5/32	3
85-905	30 (0.1285)	0.500	5/32	3
85-906	31 (0.1200)	0.500	1/8	2-1/2
85-907	32 (0.1160)	0.500	1/8	2-1/2
85-908	33 (0.1130)	0.500	1/8	2-1/2
85-909	34 (0.1110)	0.500	1/8	2-1/2
85-910	35 (0.1100)	0.500	1/8	2-1/2
85-911	36 (0.1065)	0.500	1/8	2-1/2
85-912	37 (0.1040)	0.500	1/8	2-1/2
85-913	38 (0.1015)	0.500	1/8	2-1/2
85-914	39 (0.0995)	0.500	1/8	2-1/2
85-915	40 (0.0980)	0.500	1/8	2-1/2
85-916	41 (0.0960)	0.500	1/8	2-1/2

86-100



Diamond Film Coated Solid Carbide Parabolic Drill

Designed to produce a clean, delamination free hole in composite materials. The diamond film coated (CVD) parabolic drill is an economical solution to PCD composite drills.

Usage Carbon fiber and other composite materials

Material  See Selection Guide - pg. 2 - 12

Part Number	Cutting DIA	Flute LGTH	SHK DIA	OAL
86-102	0.100	1	1/4	3
86-106	0.129	1	1/4	3
86-110	0.147	1	1/4	3
86-114	0.192	1	1/4	3
86-118	0.251	1	1/4	3
86-122	0.313	1	5/16	3
86-126	0.376	1	3/8	3
86-130	0.502	1	1/2	3

91-000 91-100



Insert Style



Carbide Tipped

Spoilboard Surfacing Cutters

Designed for surfacing MDF, particleboard and balsa core where "flow through" or "high flow" fixturing is employed using large capacity vacuum pumps. This method of surfacing spoilboards allows for much faster table planing.

Usage Aluminum, plastics and composite wood

Material    
See Selection Guide - pg. 2 - 12

STRAIGHT

Part Number	Cutting DIA	SHK DIA	SHK LGTH	# of Wings
91-000*	1-1/4	1/2	1-1/2	2
91-102	2-1/2	1/2	2	2
91-106	4	3/4	2-1/4	3

* = Carbide Tipped
Note: 90-002, 90-004, 90-006 & 90-008 use 91-125 insert and 91-130 screw
90-014 use 91-127 insert and 91-130 screw

UP-SHEAR

Part Number	Cutting DIA	SHK DIA	SHK LGTH	# of Wings
91-104	2-1/2	1/2	2	2
91-108	4	3/4	2-1/4	3
91-112*	2-1/2	1/2	2	3
91-114*	4	3/4	2-1/4	3

* Radius edges excellent for plastic and aluminum surfacing.

These tools are dynamically balanced and approved for use on CNC routers. Max RPM 18,000 1/8" Depth of cut MAX.

** DOC = Maximum Depth of Cut Proper running speed for*

Spoilboard Surfaces: 2-1/2" diameter tools should be fed at 200-600 IPM at 12,000-16,000 RPM. 4" diameter tools should be fed at 200-600 IPM at 12,000-14,000 RPM.

** Do Not Exceed 1/8" Depth Per Pass*

Part Number	Description
91-125	Insert 10/pk
91-127	Radius Insert 10/pk
91-130	Screw M4 (Old Version)
91-133	Screw M5
91-136	Wrench

ROUTER SELECTION GUIDE

The selection guide on pages 2 - 12 is a place to start making a bit selection or a place to check your current bit selection. You should try several tools and more than one tool geometry before you settle on the best tool for you specific router, set-up, fixturing and other environmental conditions.

How To Order – LMT Onsrud products are sold solely through industrial distribution. You may place an order through the authorized distributor in you market area. Should you wish the name of that distributor, please call LMT Onsrud

Guarantee – LMT Onsrud products are guaranteed against defects in material and quality of manufacture when used in the proper manner. LMT Onsrud will repair or replace tools, which have been authorized for return, if upon inspection such tools are found to be defective due to material or manufacture.

Router Laboratory – Customers, as a routine, send us panels (2' x 2') with router and feed specifications several weeks prior to the start of a new run. (We are able to duplicate most production environments in the Router Laboratory.) Armed with material, router type, spindle speed, feed rate, set up and type of cut to be made, LMT Onsrud can make a specific tool recommendation for test and evaluation in your operational environment. Should you have difficult-to-cut material or should you wish to verify your current tool selection, call the LMT Onsrud Engineering Department and arrange for a Router Laboratory test.

Technical Data

TOOL SELECTION

TOOL MATERIAL

- Solid Carbide: Primarily used in CNC operations. Material provides best rigidity and long tool life.
- Carbide Tipped: Incorporates the wear resistance of carbide and the toughness of a HSS body-mainly hand held.
- HSS: Primarily used in hand routing. Material provides a tough body and sharper cutting edge. Good in CNC.

FLUTE GEOMETRY

- Straight flute: Offers a neutral cutting action - highest force
- Upcut flute: Provides the best surface finish and allows for good chip extraction. May cause part lifting if vacuum or fixturing is not sufficient.
- Downcut flute: Provides a downward force which helps eliminate part lifting. Chip rewelding MAY occur if there is no space below the part for chip expansion.
- Compression: Used for laminated materials, produces a good top and bottom finish on the part.

NUMBER OF FLUTES

- Single Flute: Allows for larger chiploads in softer materials
- Double Flute: Allows for better part finish in harder materials.
- Multiple Flutes: Allows for an even better part finish in harder materials.

Note: As the number of cutting edges increase, your feed rate should increase to prevent burning and premature tool dulling.

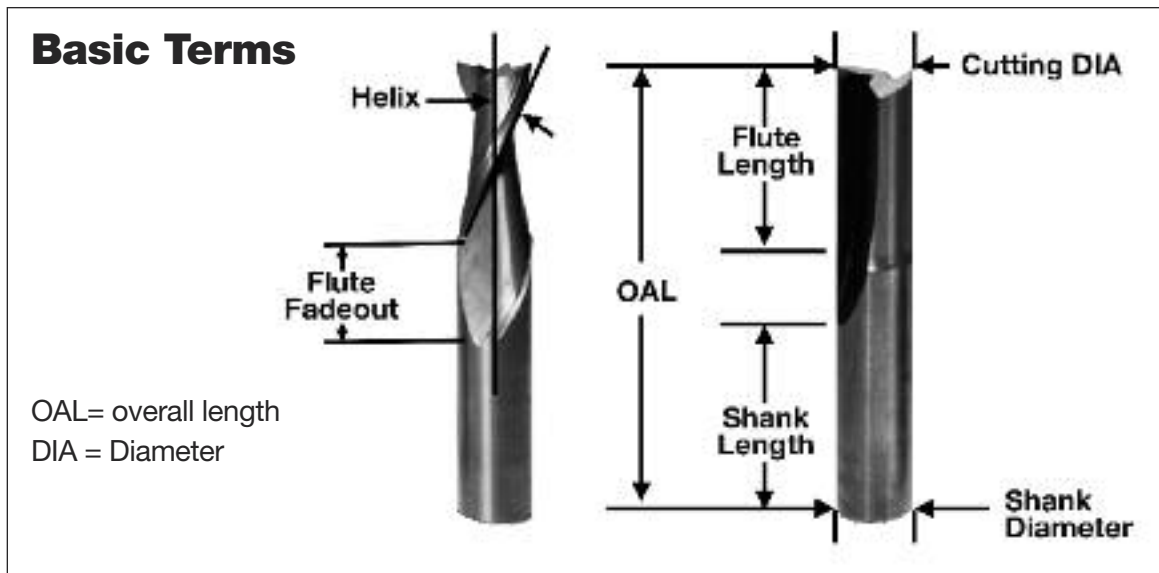

OPTIMIZING SPEED AND FEEDS

1. Start off using the recommended chipload and RPM for the material you are cutting.
2. Increase the feedrate until the part finish starts to decrease or you risk moving the part off the vacuum. Decrease the feed by 10%.
3. Next decrease your RPM by a set increment until your surface finish deteriorates again. Once this happens increase your RPM until the finish is acceptable.
4. You have now optimized your speed and feed by taking the largest chip possible.

Note: This should be done in the first sheet of material to prevent tool dulling due to excessive heat.

TOOL HEAT

If a feed rate is too low, heat will be generated causing the cutting edge to break down and dull quickly. To check this, run a nest of parts and stop the spindle. When the spindle has stopped rotating, carefully feel the tool's temperature. It should be at or near room temperature. If the tool is hot, review "Optimizing Speed and Feeds".

Technical Data

FIXTURING METHODS

FLOW THROUGH VACUUM

This style uses LDF (Low Density Fiberboard) or MDF (Medium Density Fiberboard) as a sacrificial surface for sheet material to be cut on. The porous nature of LDF or MDF allows vacuum to pass through allowing the material to be held in place for machining. As parts are cut out of the sheet material, vacuum loss starts to occur from the slot produced by the cutting tool. This can lead to part lifting or movement especially in small parts. Cutter diameter will also influence part movement. A 1/2 diameter tool will exert 25% more lateral pressure than a 3/8 diameter tool.

When cutting small parts in sheet material, one may want to consider tab or skin cutting to prevent part movement.

DEDICATED SPOILBOARD

Dedicated spoilboards are used for reoccurring production runs where optimal cycle times are needed. This work holding method creates vacuum chambers in the sacrificial board specifically to the shape of the parts being cut. This elimination of vacuum loss relates to improved cycle times and part finish.

STEPS TO CREATE A DEDICATED SPOILBOARD:

1. Surface both sides of your MDF board
2. Lay out the part pattern on the MDF and determine quantity that will fit.
3. Cut the part profile into the MDF board using a larger diameter tool than would normally cut the part.
Make your slot depth 1 to 1.5 times the cutter diameter.
4. A gasket groove must be cut next inside the part profile to create a vacuum seal. The groove should be 1/2 the gasket material thickness to allow for proper compression.
5. A grid pattern must then be cut inside the gasket groove to distribute the vacuum evenly through out the vacuum area.
6. Drill holes through out the pattern in the intersections of the vacuum grid until there is no resistance on your vacuum gage on the machine table.
7. Seal the board using rubberized coatings, polyurethane sealers or a sanding sealer to prevent vacuum from passing through the board in unwanted areas.
8. Apply the gasket tape.

Proper Spoilboard Techniques

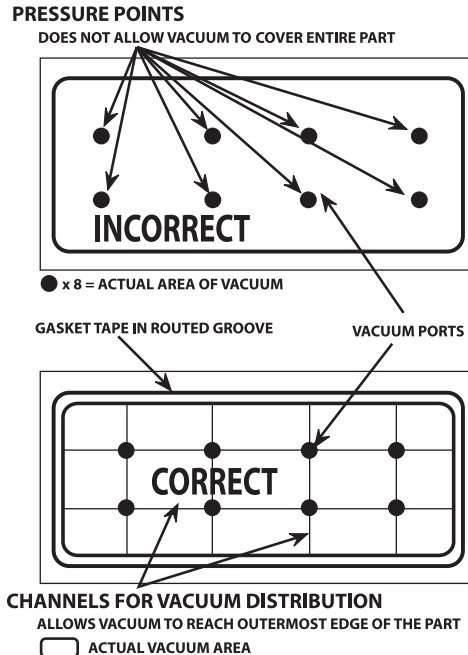

This operations sounds time consuming. It will be for your first board. Once you become familiar making these fixtures, you will make up for it in your cycle time reductions and part finish. A lot of headaches and problems can be resolved by using the proper work holding.

RAISED SPOILBOARD

This is generally used where secondary operations are needed and the spoilboard will interfere with the secondary tool.

Raised spoilboards are another type of fixturing that works well for routing parts such as circles from squares where the scrap or off-fall is of such a size to be potentially harmful to the tool and or operator when it is cut free. A raised spoilboard should make sure the off-fall would not interfere with the first and second tool and that the off-fall would be free and clear of the tool path.

SURFACING SPOILBOARDS

When creating new fixtures or using a new MDF sheet, the spoilboard must be surfaced to level the board to the machine table. This consists using a large diameter cutter (OC 91-100 series) to quickly level the entire surface.

The following benefits will be achieved by surfacing your spoilboard:

- Leveling material to get consistent cuts.
- Remove grooves caused by routing.
- Reduce vacuum loss due to clogged pores at the material surface due to dust and chips.
- Preventing material warpage caused by humidity in summer time.

Technical Data

COLLETING

COLLET LIFE SPAN

Collets have a life span of 3 months if used 8 hours a day. Replacing the collets will ensure your operation runs consistently and prevents tool breakage. When inserting a tool into the collet make sure the flute fadeout does not enter the collet. This will cause run out and potentially lead to tool breakage. To ensure proper clamping the tool shank should fill, at the minimum, 80% of the depth of the collet. If this can not be achieved, use a collet life plug to ensure a proper clamping effect.

COLLET MAINTENANCE

Cleaning is an essential part of collet maintenance. As material is cut it causes the collet, tool holder, collet nut and spindle to become dirty. This causes your tool to cut in an elliptical fashion which will decrease tool life and cause inconsistency in your operation. Collets, tool holder, and collet nut should be cleaned daily using the Rust Free solvent and a brass brush (OC series 33-21 and 33-10). Refer to the critical areas diagram to see which surfaces must be clean.

CLEANING INSTRUCTIONS

1. Spray the cleaner on the surface and allow it to soak for a minute
2. Use a brass brush to clean the surface thoroughly.
3. Rinse off using distilled alcohol. Feel the surface using your fingers to make sure the surface is clean
4. Apply a small amount of Lubricant T-9 to prevent rusting.

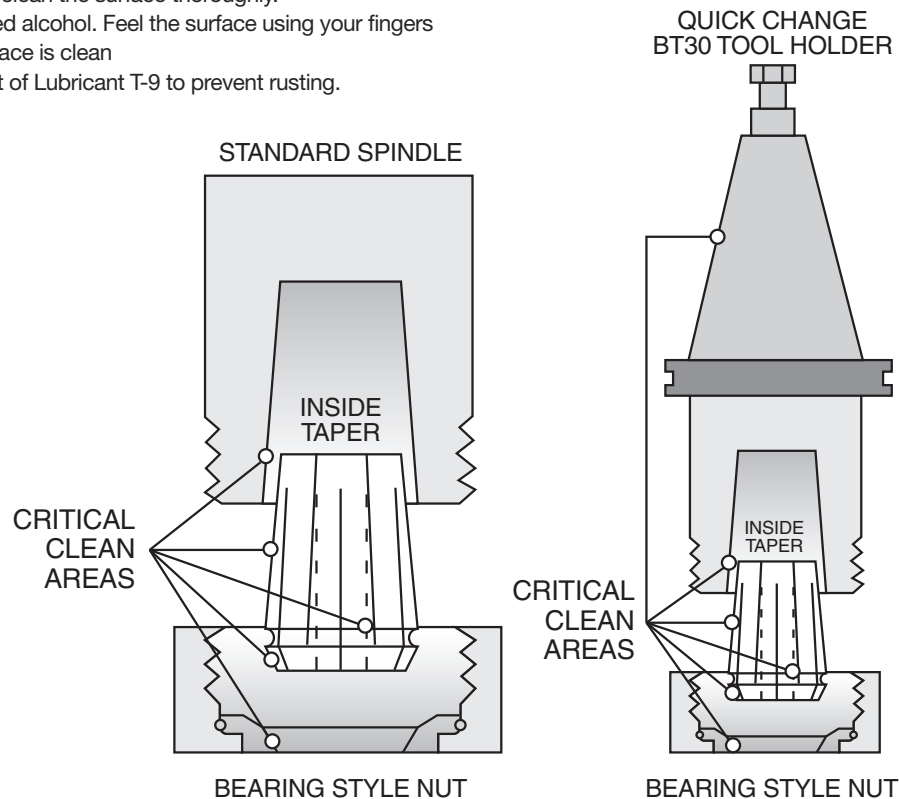

TOOL BREAKAGE

If a condition arises where multiple tools should break, follow these steps to solve your problem:

1. Are you using the proper tool for the job?
2. Make sure your collets and tool holders are clean and the tool is colleted properly.
3. Check your speed and feed (is your tool hot?)
4. Is your depth of cut too excessive for the material you're cutting?
5. Do you have any part movement?
6. Do you have ample part hold down?
7. Stop running parts and check with your distributor or Onsrud's Technical Support.

If you have to contact your distributor or Technical Support, have the following information:

1. Machine being used.
2. Material being cut.
3. Part number of tool along with the batch number which is below the part number.
4. Speed / Feed / Depth of cut.
5. Where did the tool break (flute, shank, or in the collet)?
6. How long did the tool work before it broke?
7. Have you done this operation in the past using this tool?

Honeycomb Technical Data Sheets

29-000	HONEYCOMB CORE		ALUMINUM		NOMEX		PAPER	
	Part #		RPM	Feed Rate	RPM	Feed Rate	RPM	Feed Rate
	29-003 (1/4")		500-10,000	100 IPM	500-10,000	120 IPM	500-10,000	120 IPM
	29-006 (3/8")		500-10,000	100 IPM	500-10,000	120 IPM	500-10,000	120 IPM
	29-009 (1/2")		500-10,000	100 IPM	500-10,000	120 IPM	500-10,000	120 IPM
	29-012 (5/8")		500-10,000	100 IPM	500-10,000	120 IPM	500-10,000	120 IPM
	29-015 (3/4")		500-10,000	100 IPM	500-10,000	120 IPM	500-10,000	120 IPM

29-050	SPINDLE SPEED		CORE TYPE	FEED RATE	SPINDLE SPEED		29-100
	DIA	Max RPM			Feed Rate	Max RPM	
	1/4	25,000	NR	Aluminum, less than 5#/cuft	100	25,000	1/4
	3/8	25,000	NR	Aluminum, More than 5#/cuft	100	25,000	3/8
	1/2	25,000	800	Paper based	400	25,000	1/2
	3/4	25,000	800	Paper, based w/Fiber Reinforcement	800	25,000	3/4
	1	25,000	800	Fiberglass	600		
	1-1/2	18,000	800	Phenolic	600		
	1-3/4	18,000	NR	Carbon Fiber	800		
	2	16,500	100	Aramid, less than 5#/cuft	800		
	2-1/2	15,000	100	Aramid, More than 5#/cuft	800		
	3	14,000					
	4	12,000					

30-000/ 30-300 30-700 32-200	FEEDS & SPEEDS		FEED RATES				SPINDLE SPEED	
	Core Type		Solid Carbide	Solid Carbide w/Teeth	Diamond Saw	HSS	DIA	MAX RPM
	Aluminum, Less than 5#/cuft		100	100	NR	150	1/4	25,000
	Aluminum, More than 5#/cuft		100	100	NR	100	3/8	25,000
	Paper based		400	400	NR	250	1/2	25,000
	Paper, based with Fiber Reinforcement		800	800	400	150	3/4	25,000
	Fiberglass		600	600	600	NR	1	25,000
	Phenolic		200	200	400	NR	1-1/2	18,000
	Carbon Fiber		NR	NR	800	NR	1-3/4	18,000
	Aramid, Less than 5#/cuft		800	800	400	150	2	16,500
	Aramid, More than 5#/cuft		800	800	400	NR	2-1/2	15,000
							3	14,000
							4	12,000

Note: 30-300 assembly requires one (1) hogger and one (1) blade

31-000/ 32-000	FEEDS & SPEEDS		FEED RATES					SPINDLE SPEED		
	Core Type		Solid Carbide	Diamond Plated	HSS Saw	HSS Wavy	HSS (31-000)	HSS (31-100)	DIA	MAX RPM
	Aluminum, Less than 5#/cuft		100	NR	150	100	100-140	90-140	3/8	25,000
	Aluminum, More than 5#/cuft		100	NR	100	100	70	70	1/2	25,000
	Paper based		300	NR	200	300	50	50	3/4	25,000
	Paper, based w/Fiber Reinforcement		400	300	600	300	100-150	100-150	1	25,000
	Fiberglass		NR	600	NR	NR	NR	NR	1-1/2	25,000
	Phenolic		NR	600	NR	NR	NR	NR	1-3/4	25,000
	Carbon Fiber		NR	800	NR	NR	NR	NR	2	18,000
	Aramid, Less than 5#/cuft		200	NR	150	200	100-150	100-150	2-1/2	18,000
	Aramid, More than 5#/cuft		200	400	NR	NR	NR	NR	3	18,000

34-000	Core Type	Cutter	RPM	Feed Rate	Cut Direction
	Fiberglass panels with paper core (Nomex)	Diamond Grit	18,000	220 lpm	Conventional
	Aluminum panels with aluminum core	HSS Saw	16,000	120 lpm	Conventional

Honeycomb Tool Wrench and Torque Spec

Screw	Wrench	Torque Spec
HRD51646	HRD52642	15 - 18 in-lb
30-011-2	HRD51905	15 - 18 in-lb
30-020-4	HRD51903	15 - 18 in-lb
30-030-4	HRD51904	15 - 18 in-lb
30-040-4	HRD52608	15 - 18 in-lb
32-000 Series	32-100	15 - 18 in-lb
32-221-4	32-202	18 in-lb
32-231-4	32-201	18 in-lb



Soft Wood Cutting Data

APPLICATION	GOOD	BETTER	BEST
Single Pass		60-100	52-200/57-200
Roughing	52-700	60-000	60-850
Finishing		52-200/57-200	60-200

DEPTH OF CUT: 1 x D Use recommended chip load
 2 x D Reduce chip load by 25%
 3 x D Reduce chip load by 50%

CHIP LOAD PER TOOTH

		Cutting Edge Diameter																					
Series	Cut	1/16	3/32	1/8	5/32	3/16	7/32	1/4	5/16	3/8	7/16	1/2	9/16	5/8	3/4	7/8	1	1 1/8	1 1/4	1 1/2	1 3/4	2	
10-00	1 x D	.004-.006	.004-.006	.005-.007				.007-.009		.008-.010													
37-50/60	1/2 CED					.001-.003		.002-.004		.003-.005					.005-.007		.007-.009						
37-80	1 x D												.003-.005						.004-.006		.004-.006*		.004-.006**
40-50	1 1/2												.003-.005										
40-000	1 x D			.002-.004	.002-.004	.003-.005		.004-.006	.004-.006	.005-.007													
40-100	1 x D			.005-.007		.005-.007	.005-.007	.006-.008	.006-.008	.007-.009		.008-.010				.010-.012							
52-200/57-200	1 x D			.006-.008	.006-.008	.006-.008	.006-.008	.007-.009	.007-.009	.008-.010	.008-.010	.009-.011	.009-.011	.010-.012	.011-.013								
52-400/57-400	1 x D				.006-.008	.006-.008		.007-.009	.007-.009	.008-.010		.009-.011											
52-900	1 x D							.007-.009		.008-.010		.009-.011											
56-200	1 x D			.004-.006	.004-.006	.005-.007	.005-.007	.006-.008	.006-.008	.007-.009	.008-.010				.010-.012								
57-900	1 x D							.007-.009		.008-.010		.009-.011											
60-000 (LH)	1 x D									.013-.015	.015-.017			.017-.019	.019-.021								
60-000 (HH)	1 x D									.016-.018	.018-.020			.020-.022	.022-.024								
60-090	1 x D													.005-.007									
60-100	1 x D			.011-.013		.013-.015		.015-.017		.017-.019	.019-.021	.021-.023		.021-.023									
60-100DE	1 x D							.018-.020		.020-.022	.022-.024	.022-.024		.024-.026	.026-.028								
60-1003E	1 x D									.017-.019	.019-.021												
60-100C	1 x D									.024-.026	.026-.028			.028-.030	.030-.032								
60-100MC	1 x D									.019-.021	.021-.023												
60-200	1 x D							.005-.007		.006-.008	.007-.009				.008-.010								
60-300	1 x D									.024-.026	.026-.028			.028-.030	.030-.032								
60-350	1 x D									.017-.019	.019-.021				.021-.023								
60-500/500M	1 x D											.015-.017		.017-.019	.019-.021								
60-600	1 x D											.019-.021			.023-.025								
60-700	1 x D											.019-.021		.021-.023	.023-.025								
60-800	1 x D									.017-.019	.019-.021			.021-.023	.023-.025								
60-900	1 x D									.017-.019	.018-.020												
60-950	1 x D									.024-.026	.026-.028												
61-000	1 x D			.008-.010	.008-.010	.009-.011	.009-.011	.010-.012	.010-.012	.011-.013	.011-.013	.011-.013	.012-.014										
61-200	1 x D			.008-.010				.010-.012	.010-.012	.011-.013		.012-.014											
64-000/65-000	1 x D	.001-.003		.002-.004		.003-.006		.004-.006		.005-.007													
77-100 (DE)	1 x D			.003-.005																			
77-100 (3E)	1 x D							.005-.007															

* = 16,000 RPM
 ** = 15,000 RPM

FORMULAS: Chip Load = Feed Rate / (RPM x # of cutting edges)
 Feed Rate (IPM) = RPM x # of cutting edges x chip load
 Speed (RPM) = Feed Rate / (# of cutting edges x chip load)

DEFINITIONS: IPM = Inches Per Minute
 IPR = Inches Per Revolution



Hard Wood Cutting Data

APPLICATION	GOOD	BETTER	BEST
Single Pass	52-700	52-200/57-200	60-300/60-350
Roughing	52-700	60-000	60-800/66-900
Finishing		60-300/60-350	60-200

DEPTH OF CUT: 1 x D Use recommended chip load
 2 x D Reduce chip load by 25%
 3 x D Reduce chip load by 50%

CHIP LOAD PER TOOTH

		Cutting Edge Diameter																					
Series	Cut	1/16	3/32	1/8	5/32	3/16	7/32	1/4	5/16	3/8	7/16	1/2	9/16	5/8	3/4	7/8	1	1 1/8	1 1/4	1 1/2	1 3/4	2	
12-00	1 x D			.002-.004	.002-.004		.003-.005	.003-.005		.004-.006	.005-.007	.005-.007				.010-.012							
37-50/60	1/2 CED					.002-.004		.002-.004				.003-.005			.005-.007		.007-.009						
37-80	1 x D																.004-.006			.004-.006*		.004-.006**	
40-50	1 1/2											.003-.005											
40-000	1 x D			.006-.008	.006-.008	.007-.009		.008-.010	.008-.010	.009-.007		.010-.012											
40-100	1 x D			.004-.006		.005-.007	.005-.007	.005-.007	.006-.008	.006-.008		.007-.009			.009-.011								
48-000	1 x D					.004-.006		.005-.007	.005-.007	.005-.007		.006-.008		.007-.009	.008-.010	.009-.011	.010-.012	.011-.013	.012-.014	.013-.015	.014-.016	.015-.017	
52-200/57-200	1 x D			.003-.005	.003-.005	.004-.006	.004-.006	.005-.007	.005-.007	.006-.008	.006-.008	.007-.009	.007-.008	.008-.010	.009-.011								
52-400/57-400	1 x D				.004-.006	.004-.006		.005-.007	.005-.007	.006-.008		.007-.009											
52-900	1 x D							.006-.008		.007-.009		.007-.009											
56-200	1 x D			.003-.005	.003-.005	.004-.006	.004-.006	.005-.007	.005-.007	.006-.008		.007-.009			.009-.011								
57-900	1 x D							.005-.007		.006-.008		.007-.009											
60-000 (LH)	1 x D									.013-.015		.014-.016		.016-.018	.017-.019								
60-000 (HH)	1 x D									.015-.017		.017-.019			.019-.021	.021-.023							
60-090	1 x D													.005-.007									
60-100	1 x D			.010-.012		.012-.014		.014-.016		.016-.018		.018-.020		.020-.022	.022-.024								
60-100DE	1 x D							.014-.016		.016-.018		.018-.020		.020-.022	.022-.024								
60-1003E	1 x D									.016-.018		.018-.020											
60-100C	1 x D									.019-.021		.021-.023		.023-.025	.025-.027								
60-100MC	1 x D									.019-.021		.021-.023											
60-500/500M	1 x D											.013-.015		.015-.017	.016-.018								
60-600	1 x D											.018-.020			.022-.024								
60-700	1 x D											.018-.020		.020-.022	.022-.024								
60-800	1 x D									.017-.019		.019-.021		.021-.023	.023-.025								
60-900	1 x D									.015-.017		.017-.019		.019-.021	.021-.023								
60-950	1 x D									.019-.021		.021-.023											
61-200	1 x D			.007-.009				.009-.011	.009-.011	.010-.012													
64-000/65-000	1 x D	.001-.003		.002-.004		.003-.005		.004-.006		.005-.007													
77-100 (DE)	1 x D			.003-.005																			
77-100 (3E)	1 x D							.005-.007															

* = 16,000 RPM
 ** = 15,000 RPM

FORMULAS: Chip Load = Feed Rate / (RPM x # of cutting edges)
 Feed Rate (IPM) = RPM x # of cutting edges x chip load
 Speed (RPM) = Feed Rate / (# of cutting edges x chip load)

DEFINITIONS: IPM = Inches Per Minute
 IPR = Inches Per Revolution

APPLICATION	GOOD	BETTER	BEST
Single Pass	52-200/57-200	60-300/60-350	60-100
Roughing		60-000	60-850
Finishing		60-300/60-350	60-200

DEPTH OF CUT: 1 x D Use recommended chip load
 2 x D Reduce chip load by 25%
 3 x D Reduce chip load by 50%

CHIP LOAD PER TOOTH

		Cutting Edge Diameter																					
Series	Cut	1/16	3/32	1/8	5/32	3/16	7/32	1/4	5/16	3/8	7/16	1/2	9/16	5/8	3/4	7/8	1	1 1/8	1 1/4	1 1/2	1 3/4	2	
37-50/60	1/2 CED					.001-.003		.001-.003		.002-.004		.003-.005			.005-.007		.007-.009						
37-80	1 x D																.004-.006				.004-.006*		.004-.006**
40-50	1 1/2											.003-.005											
47-00	1 x D																.004-.006				.004-.006		.004-.006
48-000	1 x D					.004-.006		.005-.007	.005-.007	.005-.007		.006-.008		.006-.008	.007-.009	.008-.010	.009-.011						
52-200/57-200	1 x D			.005-.007	.005-.007	.006-.008	.006-.008	.006-.008	.006-.008	.007-.009	.007-.009	.008-.010	.008-.010	.009-.011	.009-.011								
52-400/57-400	1 x D				.003-.005	.004-.006		.005-.007	.005-.007	.006-.008		.008-.010	.009-.011	.010-.012	.011-.013	.012-.014							
52-900	1 x D							.006-.008		.007-.009		.008-.010											
56-200	1 x D			.003-.005	.003-.005	.004-.006	.004-.006	.005-.007	.005-.007	.006-.008		.007-.009			.009-.011								
57-900	1 x D							.006-.008		.007-.009		.008-.010											
60-000 (LH)	1 x D									.012-.014		.013-.015		.014-.016	.016-.018								
60-000 (HH)	1 x D									.017-.019		.018-.020		.020-.022	.023-.025								
60-090	1 x D													.004-.006									
60-100	1 x D			.010-.012		.010-.012		.013-.015		.014-.016		.016-.018	.017-.019	.019-.021									
60-100DE	1 x D							.013-.015		.014-.016		.016-.018	.018-.020	.019-.021									
60-1003E	1 x D									.014-.016		.016-.018			.018-.020								
60-100C	1 x D									.017-.019		.018-.020		.020-.022	.023-.025								
60-100MC	1 x D									.019-.021		.021-.023											
60-200	1 x D							.004-.006		.005-.007		.005-.007			.006-.008								
60-300	1 x D									.017-.019		.018-.020		.020-.022	.023-.025								
60-350	1 x D									.014-.016		.016-.018		.017-.019	.019-.021								
60-500/500M	1 x D											.014-.016		.016-.018	.018-.020								
60-600	1 x D											.020-.022		.022-.024	.024-.026								
60-700	1 x D											.020-.022		.022-.024	.024-.026								
60-800	1 x D									.017-.019		.019-.021		.021-.023	.023-.025								
60-900	1 x D									.017-.019		.019-.021											
60-950	1 x D									.017-.019		.018-.020											
61-200	1 x D			.007-.009		.008-.010		.009-.011	.009-.011	.010-.012		.011-.013											
62-200	1 x D			.010-.012		.011-.013		.012-.014	.012-.014	.013-.015		.014-.016											
64-000/65-000	1 x D	.001-.003		.002-.004		.003-.005		.004-.006		.005-.007													
68-100	1 x D									.008-.010		.012-.014		.015-.017	.018-.020								
77-100 (DE)	1 x D			.003-.005																			
77-100 (3E)	1 x D							.005-.007															

* = 16,000 RPM
 ** = 15,000 RPM

FORMULAS: Chip Load = Feed Rate / (RPM x # of cutting edges)
 Feed Rate (IPM) = RPM x # of cutting edges x chip load
 Speed (RPM) = Feed Rate / (# of cutting edges x chip load)

DEFINITIONS: IPM = Inches Per Minute
 IPR = Inches Per Revolution



Soft Plywood Cutting Data

APPLICATION	GOOD	BETTER	BEST
Single Pass	60-300/60-350	60-100	60-100C
Roughing		60-800	60-000
Finishing		60-300/60-350	60-200

DEPTH OF CUT: 1 x D Use recommended chip load
 2 x D Reduce chip load by 25%
 3 x D Reduce chip load by 50%

CHIP LOAD PER TOOTH

		Cutting Edge Diameter																			
Series	Cut	1/16	1/8	5/32	3/16	7/32	1/4	5/16	3/8	7/16	1/2	9/16	5/8	3/4	7/8	1	1-1/8	1-1/4	1-1/2	2	
37-50/60	1/2 CED				.001-.003		.002-.004		.002-.004		.003-.005			.004-.006		.006-.008					
37-80	1 x D															.004-.006				.004-.006*	.004-.006**
40-50	1 1/2										.003-.005										
48-000	1 x D				.005-.007		.005-.007	.006-.008	.006-.008		.007-.009		.008-.010	.009-.011	.010-.012	.011-.013	.012-.014	.013-.015			
56-200	1 x D		.003-.005	.003-.005	.004-.006	.004-.006	.005-.007	.005-.007	.006-.008		.007-.009			.009-.011							
60-000 (LH)	1 x D								.014-.016		.016-.018		.018-.020	.020-.022							
60-000 (HH)	1 x D								.017-.019		.019-.021		.021-.023	.023-.025							
60-090	1 x D												.003-.005								
60-100	1 x D		.013-.015		.014-.016		.015-.017		.016-.018		.018-.020		.020-.022	.022-.024							
60-100DE	1 x D						.017-.019		.019-.021		.021-.023		.023-.025	.025-.027							
60-1003E	1 x D								.020-.022		.022-.024			.024-.026							
60-100C	1 x D								.022-.024		.024-.026		.026-.028	.028-.030							
60-100MC	1 x D								.019-.021		.021-.023										
60-300	1 x D								.022-.024		.024-.026		.026-.028	.028-.030							
60-350	1 x D								.020-.022		.022-.024		.024-.026	.026-.028							
60-500/ 500M	1 x D										.021-.023		.023-.025	.025-.027							
60-600	1 x D										.028-.030		.030-.032	.032-.034							
60-700	1 x D										.028-.030		.030-.032	.032-.034							
60-800	1 x D								.017-.019		.019-.021		.021-.023	.023-.025							
60-900	1 x D								.017-.019		.019-.021										
60-950	1 x D								.022-.024		.024-.026										
61-200	1 x D		.006-.008		.007-.009		.008-.010	.008-.010	.009-.011		.010-.012										
64-000/ 65-000	1 x D	.001-.003	.002-.004		.003-.005		.004-.006		.005-.007												
68-100									.010-.012		.012-.014		.017-.019	.018-.020							

* = 16,000 RPM
 ** = 15,000 RPM

FORMULAS: Chip Load = Feed Rate / (RPM x # of cutting edges)
 Feed Rate (IPM) = RPM x # of cutting edges x chip load
 Speed (RPM) = Feed Rate / (# of cutting edges x chip load)

DEFINITIONS: IPM = Inches Per Minute
 IPR = Inches Per Revolution

APPLICATION	GOOD	BETTER	BEST
Single Pass	60-300/60-350	60-100	60-100C
Roughing		60-800	60-000
Finishing		60-300/60-350	60-200

DEPTH OF CUT: 1 x D Use recommended chip load
 2 x D Reduce chip load by 25%
 3 x D Reduce chip load by 50%

CHIP LOAD PER TOOTH

		Cutting Edge Diameter																					
Series	Cut	1/16	3/32	1/8	5/32	3/16	7/32	1/4	5/16	3/8	7/16	1/2	9/16	5/8	3/4	7/8	1	1 1/8	1 1/4	1 1/2	1 3/4	2	
37-50I60	1/2 CED					.001-.003		.001-.003		.002-.004		.003-.005			.005-.007		.007-.009						
37-80	1 x D																.004-.006				.004-.006*		.004-.006**
40-50	1 1/2											.003-.005											
48-000	1 x D					.004-.006		.005-.007	.005-.007	.006-.008		.007-.009		.008-.010	.009-.011	.010-.012	.011-.013	.012-.014	.013-.015				
56-200	1 x D			.003-.005	.003-.005	.004-.006	.004-.006	.005-.007	.005-.007	.006-.008		.007-.009		.008-.010	.009-.011								
60-000 (LH)	1 x D									.014-.016		.016-.018		.018-.020	.020-.022								
60-000 (HH)	1 x D									.017-.019		.019-.021		.021-.023	.023-.025								
60-090	1 x D													.003-.005									
60-100	1 x D			.012-.018		.012-.018		.014-.016		.016-.018		.018-.020		.020-.022	.022-.024								
60-100DE	1 x D							.014-.016		.016-.018		.018-.020		.020-.022	.022-.024								
60-1003E	1 x D									.020-.022		.022-.024		.024-.026	.026-.028								
60-100C	1 x D									.019-.021		.021-.023		.023-.025	.025-.027								
60-100MC	1 x D									.019-.021		.021-.023		.023-.025	.025-.027								
60-300	1 x D									.019-.021		.021-.023		.023-.025	.025-.027								
60-350	1 x D									.018-.020		.020-.022		.022-.025	.024-.026								
60-500/ 500M	1 x D											.039-.041		.043-.045	.047-.049								
60-600	1 x D											.027-.029		.030-.032	.032-.034								
60-700	1 x D											.027-.029		.029-.031	.032-.034								
60-800	1 x D									.017-.019		.019-.021		.021-.023	.023-.025								
60-900	1 x D									.017-.019		.019-.021											
60-950	1 x D									.019-.021		.021-.023											
61-200	1 x D			.005-.007				.007-.009	.007-.009	.008-.010		.009-.011											
64-000/ 65-000	1 x D	.001-.003		.002-.004		.003-.005		.004-.006		.005-.007													
68-100	1 x D									.010-.012		.012-.014		.017-.019	.018-.020								

* = 16,000 RPM
 ** = 15,000 RPM

FORMULAS: Chip Load = Feed Rate / (RPM x # of cutting edges)
 Feed Rate (IPM) = RPM x # of cutting edges x chip load
 Speed (RPM) = Feed Rate / (# of cutting edges x chip load)

DEFINITIONS: IPM = Inches Per Minute
 IPR = Inches Per Revolution



Laminated Chipboard Cutting Data

APPLICATION	GOOD	BETTER	BEST
Single Pass	60-100	60-100MW	60-100MC
Roughing			60-850

DEPTH OF CUT: 1 x D Use recommended chip load
 2 x D Reduce chip load by 25%
 3 x D Reduce chip load by 50%

CHIP LOAD PER TOOTH

		Cutting Edge Diameter															
Series	Cut	1/8	3/16	7/32	1/4	5/16	3/8	1/2	9/16	5/8	3/4	7/8	1	1-1/8	1-1/4	1-1/2	2
37-80	1 x D												.004-.006			.004-.006*	.004-.006**
48-000	1 x D		.005-.007	.005-.007	.006-.008	.006-.008	.007-.009	.008-.010		.009-.011	.010-.012	.011-.013	.012-.014	.013-.015	.014-.016		
60-100	1 x D	.013-.015	.014-.016		.015-.017		.016-.018	.018-.020		.019-.021	.021-.023						
60-100 (DE)	1 x D				.017-.019		.019-.021	.021-.023		.025-.027	.027-.029						
60-100 (3E)	1 x D						.020-.022	.022-.024			.024-.026						
60-100C	1 x D						.022-.024	.024-.026		.026-.028	.028-.030						
60-100MC	1 x D						.019-.021	.021-.023									
60-500/500M	1 x D							.021-.023		.023-.025	.025-.027						
60-600	1 x D							.028-.030		.030-.032	.032-.034						
68-100	1 x D						.008-.010	.012-.014		.016-.018	.019-.021						

* = 16,000 RPM
 ** = 15,000 RPM

FORMULAS: Chip Load = Feed Rate / (RPM x # of cutting edges)
 Feed Rate (IPM) = RPM x # of cutting edges x chip load
 Speed (RPM) = Feed Rate / (# of cutting edges x chip load)

DEFINITIONS: IPM = Inches Per Minute
 IPR = Inches Per Revolution



Laminated Plywood Cutting Data

APPLICATION	GOOD	BETTER	BEST
Single Pass	60-100	60-100MW	60-100MC
Roughing			60-850

DEPTH OF CUT: 1 x D Use recommended chip load
 2 x D Reduce chip load by 25%
 3 x D Reduce chip load by 50%

CHIP LOAD PER TOOTH

		Cutting Edge Diameter																					
Series	Cut	1/16	3/32	1/8	5/32	3/16	7/32	1/4	5/16	3/8	7/16	1/2	9/16	5/8	3/4	7/8	1	1 1/8	1 1/4	1 1/2	1 3/4	2	
37-80	1xD																.004-.006				.004-.006*		.004-.006**
48-000	1xD					.004-.006	.005-.007	.005-.007	.006-.008	.006-.008		.007-.009		.009-.011	.010-.012	.011-.013	.012-.014	.013-.015	.014-.016				
60-100	1xD			.013-.015		.014-.016		.015-.017		.016-.018		.018-.020		.019-.021	.021-.023								
60-100DE	1xD							.015-.017		.016-.018		.018-.020		.019-.021	.021-.023								
60-1003E	1xD									.018-.020		.020-.022			.022-.024								
60-100C	1xD									.019-.021		.021-.023		.023-.025	.025-.027								
60-100MC	1xD									.019-.021		.021-.023											
60-500/ 500M	1xD											.019-.021		.021-.023	.023-.025								
60-600	1xD											.027-.029		.030-.032	.032-.034								
68-100	1xD									.008-.010		.012-.014		.016-.018	.019-.021								
77-100 (DE)	1xD			.003-.005																			
77-100 (SE)	1xD							.005-.007															

* = 16,000 RPM
 ** = 15,000 RPM

FORMULAS: Chip Load = Feed Rate / (RPM x # of cutting edges)
 Feed Rate (IPM) = RPM x # of cutting edges x chip load
 Speed (RPM) = Feed Rate / (# of cutting edges x chip load)

DEFINITIONS: IPM = Inches Per Minute
 IPR = Inches Per Revolution



Soft Plastic Cutting Data

< 1/2" DIAMETER TOOL

APPLICATION	GOOD	BETTER	BEST
Single Pass	61-000P	65-000	63-750
Roughing			60-000

DEPTH OF CUT: 1 x D Use recommended chip load
 2 x D Reduce chip load by 25%
 3 x D Reduce chip load by 50%

> 1/2" DIAMETER TOOL

APPLICATION	GOOD	BETTER	BEST
Single Pass	56-600	52-700	52-600
Roughing			60-000

CHIP LOAD PER TOOTH

		Cutting Edge Diameter																					
Series	Cut	1/16	3/32	1/8	5/32	3/16	7/32	1/4	5/16	3/8	7/16	1/2	9/16	5/8	3/4	7/8	1	1 1/8	1 1/4	1 1/2	1 3/4	2	
10-00	1 x D	.002 - .004		.004 - .006		.006 - .008		.006 - .008		.007 - .009		.008 - .010											
38-50/ 38-60	1 x D			.001 - .003		.002 - .004		.003 - .005		.004 - .006		.005 - .007		.006 - .008	.007 - .009								
52-200B/BL	1 x D	.002 - .004		.002 - .004		.004 - .006		.004 - .006		.004 - .006		.006 - .008		.010 - .012	.012 - .014								
52-400	1 x D			.002 - .004		.003 - .005		.004 - .006		.005 - .007		.006 - .008		.007 - .009									
52-600	1 x D									.008 - .010		.010 - .012		.012 - .014	.014 - .016	.016 - .018							
52-700	1 x D											.012 - .014		.014 - .016	.016 - .018								
56-430	1 x D			.006 - .008		.006 - .008		.007 - .009		.008 - .010		.009 - .011											
56-600	1 x D			.004 - .006		.006 - .008		.008 - .010		.010 - .012		.012 - .014											
57-600	1 x D							.008 - .010		.010 - .012		.012 - .014		.014 - .016	.016 - .018								
60-000	1 x D									.004 - .006		.006 - .008		.008 - .010	.012 - .014								
60-200	1 x D							.004 - .006		.004 - .006		.006 - .010			.012 - .016								
60-900	1 x D									.004 - .006		.006 - .008											
61-000P	1 x D			.004 - .006		.006 - .008		.008 - .012		.014 - .018		.018 - .022											
61-400	1 x D			.017 - .019		.017 - .019		.018 - .020		.019 - .021		.020 - .021											
62-750	1 x D			.004 - .006		.006 - .008		.008 - .012		.008 - .012		.010 - .014											
62-850	1 x D			.004 - .006		.006 - .008		.008 - .012		.008 - .012		.010 - .014											
63-500	1 x D	.002 - .004		.004 - .006		.005 - .007		.006 - .008		.007 - .009													
63-750	1 x D	.002 - .004		.004 - .006		.006 - .008		.008 - .012		.008 - .012		.010 - .014											
63-850	1 x D	.002 - .004		.004 - .006		.006 - .008		.008 - .012		.008 - .012		.010 - .014											
64-000/ 65-000	1 x D	.002 - .004		.004 - .006		.006 - .008		.008 - .012		.008 - .012													
65-200B/ 65-300B	1 x D	.002-003		.002-003		.003-004		.003-005	.003-005	.004-006		.006-008											
77-100 (DE)	1 x D			.005 - .007																			
77-100 (SE)	1 x D							.008 - .010															

* = 12,500 RPM

NOTE: To eliminate rewelding increase the feedrate or change to a single edge tool
 If using a downcut spiral and chip rewelding occurs, cut a slot in your spoilboard to allow the chips a place to expand
 Incorrect chiploads can lead to knife marks occurring

FORMULAS: Chip Load = Feed Rate / (RPM x # of cutting edges)
 Feed Rate = RPM x # of cutting edges x chip load
 Speed (RPM) = Feed Rate / (# of cutting edges x chip load)



Hard Plastic Cutting Data

< 1/2" DIAMETER TOOL

APPLICATION	GOOD	BETTER	BEST
Single Pass	65-000	63-700	56-000P
Roughing			60-000
Finishing		60-200	75-000

DEPTH OF CUT: 1 x D Use recommended chip load
 2 x D Reduce chip load by 25%
 3 x D Reduce chip load by 50%

> 1/2" DIAMETER TOOL

APPLICATION	GOOD	BETTER	BEST
Single Pass	52-700	52-600	56-000P
Roughing			60-000
Finishing			60-200

CHIP LOAD PER TOOTH

		Cutting Edge Diameter																					
Series	Cut	1/16	3/32	1/8	5/32	3/16	7/32	1/4	5/16	3/8	7/16	1/2	9/16	5/8	3/4	7/8	1	1 1/8	1 1/4	1 1/2	1 3/4	2	
52-200B/BL	1 x D	.002 - .004		.002 - .004		.004 - .006		.004 - .006		.004 - .006		.006 - .008		.008 - .010	.010 - .012								
52-600	1 x D							.006 - .008		.008 - .010		.010 - .012		.012 - .014	.014 - .016								
56-000P	1 x D			.002 - .004		.004 - .006		.004 - .006		.006 - .008		.008 - .010											
56-430	1 x D			.005 - .007		.005 - .007		.006 - .008		.007 - .009		.008 - .010											
56-450	1 x D					.005 - .007		.006 - .008		.007 - .009		.008 - .010											
56-600	1 x D			.003 - .005		.005 - .007		.007 - .009		.009 - .011		.011 - .013											
57-600	1 x D							.006 - .008		.008 - .010		.010 - .012		.012 - .014	.014 - .016								
60-000	1 x D									.004 - .006		.006 - .008		.008 - .010	.012 - .016								
60-200	1 x D							.004 - .006		.004 - .006		.006 - .010			.012 - .016								
60-900	1 x D									.004 - .006		.006 - .008											
61-000P	1 x D			.003 - .005		.005 - .007		.007 - .011		.013 - .017		.017 - .021											
61-400	1 x D			.014 - .016		.014 - .016		.015 - .017		.016 - .018		.017 - .019											
62-700	1 x D			.006 - .008		.008 - .010		.010 - .012		.010 - .012		.012 - .016											
62-750	1 x D			.004 - .006		.006 - .008		.008 - .012		.008 - .012		.010 - .014											
62-800	1 x D			.006 - .008		.008 - .010		.010 - .012		.010 - .012		.012 - .016											
62-850	1 x D			.004 - .006		.006 - .008		.008 - .012		.008 - .012		.010 - .014											
63-500	1 x D	.002 - .004		.003 - .005		.003 - .005		.004 - .006		.005 - .007													
63-700	1 x D	.002 - .004		.006 - .008		.008 - .010		.010 - .012		.010 - .012		.012 - .016											
63-750	1 x D	.002 - .004		.004 - .006		.006 - .008		.008 - .012		.008 - .012		.010 - .014											
63-800	1 x D	.002 - .004		.006 - .008		.008 - .010		.010 - .012		.010 - .012		.012 - .016											
63-850	1 x D	.002 - .004		.004 - .006		.006 - .008		.008 - .012		.008 - .012		.010 - .014											
64-000/ 65-000	1 x D	.002 - .004		.006 - .008		.008 - .010		.010 - .012		.010 - .012													
77-000	1 x D	.002 - .004		.002 - .004		.006 - .008		.008 - .012															
77-100 (DE)	1 x D			.005 - .007																			
77-100 (SE)	1 x D							.008 - .010															

NOTE: When chip rewelding occurs while cutting soft plastic, increase feedrate or go to a single edge tool. Incorrect chiploads can result in cratering

FORMULAS: Chip Load = Feed Rate / (RPM x # of cutting edges)
 Feed Rate (IPM) = RPM x # of cutting edges x chip load
 Speed (RPM) = Feed Rate / (# of cutting edges x chip load)

DEFINITIONS: IPM = Inches Per Minute
 IPR = Inches Per Revolution



Composite Cutting Data

APPLICATION	GOOD	BETTER	BEST
Finishing			54-200
Honeycomb	67-300	32-000	30-300
CFRP	66-900	66-800	68-300
G10/G11 Fiberglass	56-000P	67-000	54-200
Fiberglass	67-000	67-400	67-200
Phenolic	53-000P	67-200	67-220
Single Pass	56-000P	67-250	68-000

DEPTH OF CUT: 1 x D Use recommended chip load
 2 x D Reduce chip load by 25%
 3 x D Reduce chip load by 50%

CHIP LOAD PER TOOTH

		Cutting Edge Diameter																				
Series	Cut	1/16	3/32	1/8	5/32	3/16	7/32	1/4	5/16	3/8	7/16	1/2	9/16	5/8	3/4	7/8	1	1 1/8	1 1/4	1 1/2	1 3/4	2
48-000	1xD			.006-.008		.006-.008		.007-.009	.007-.009	.008-.010		.009-.011		.010-.012	.011-.013		.012-.014		.013-.015	.014-.016	.015-.017	.016-.018
48-000DE	1xD			.002-.004		.002-.004		.003-.005	.003-.005	.004-.006		.005-.007		.006-.008	.007-.009		.008-.010		.009-.011	.010-.012	.011-.013	.012-.014
52-000	1xD			.003-.005		.003-.005		.004-.006		.006-.008		.010-.012										
54-000 / 58-000	1xD			.002-.004		.002-.004		.002-.004		.003-.006		.005-.010										
54-200	1xD			.002-.004		.002-.004		.002-.004		.003-.006		.005-.010										
54-300	1xD									.007-.009		.008-.010										
55-000 / 58-000	1xD			.002-.004		.002-.004		.002-.004		.003-.006		.007-.009										
55-300	1xD									.007-.009		.008-.010										
56-000P	1xD			.002-.004		.002-.004		.004-.006		.004-.006		.004-.006										
56-450	1xD					.002-.005		.003-.005	.003-.006	.004-.006		.005-.007										
57-000	1xD			.003-.005		.003-.005		.004-.006		.006-.008		.010-.012										
63-000	1xD			.003-.005		.003-.005		.003-.005	.004-.006			.005-.007										
66-800	1xD							.001-.002		.002-.003		.003-.004										
66-900	1xD			.002-.004		.002-.004		.004-.006		.004-.006		.006-.008										
67-000	1xD							.004-.006		.004-.006		.004-.006										
67-200	1xD									.002-.010		.002-.010										
67-220	1xD									.001-.002		.001-.002										
67-250	1xD			.002-.004				.004-.006		.004-.006												
67-300	1xD							.004-.006		.006-.008		.010-.012										
67-400	1xD			.002-.004				.004-.006		.004-.006		.004-.006										
67-500	1xD			.001-.003		.001-.003		.002-.004	.002-.004	.003-.005		.004-.006										
67-600	1xD			.002-.004		.002-.004		.003-.005	.003-.005	.004-.006		.005-.007										
68-000	1xD							.004-.006		.004-.006		.004-.006			.008-.010							
68-200	1xD							.0005-.001		.001-.002		.001-.002										
68-300	1xD									.001-.002		.001-.002			.004-.006							

* = 10,000 RPM

NOTE: Spindle RPM's generally range from 9,000 - 12,000 when cutting composite materials

FORMULAS: Chip Load = Feed Rate / (RPM x # of cutting edges)
 Feed Rate (IPM) = RPM x # of cutting edges x chip load
 Speed (RPM) = Feed Rate / (# of cutting edges x chip load)

DEFINITIONS: IPM = Inches Per Minute
 IPR = Inches Per Revolution



Aluminum Cutting Data

APPLICATION	GOOD	BETTER	BEST
BLOCK			
Single Pass	63-600	52-000	AMC
Roughing	40-000	52-000	AMC
Finishing		66-300	AMC
Slotting	63-600	52-000	AMC
Profile/Shape		52-200B	AMC
SHEET			
Single Pass	40-000	65-000	63-600
EXTRUSION			
Single Pass	63-600	81-000	81-100

DEPTH OF CUT: 1 x D Use recommended chip load
 2 x D Reduce chip load by 25%
 3 x D Reduce chip load by 50%

To view our complete line of **AMC Tools**, reference our **Milling Tools Catalog** which is available at www.onsrud.com

CHIP LOAD PER TOOTH

Cutting Edge Diameter																	
Series	Cut	1/16	3/32	1/8	5/32	3/16	7/32	1/4	5/16	3/8	7/16	1/2	9/16	5/8	3/4	7/8	1
40-000*	1 x D			.005 - .007		.005 - .007		.006 - .008	.006 - .008	.007 - .009		.008 - .010					
40-100	1 x D			.001 - .003		.001 - .003		.002 - .004	.002 - .004	.003 - .005		.004 - .008			.006 - .008		
52-000	1 x D			.003 - .005		.003 - .005		.004 - .006		.006 - .008		.010 - .012					
52-200B/BL	1 x D	.002 - .004		.003 - .005		.003 - .005		.004 - .006		.006 - .008		.010 - .012		.012 - .014	.014 - .016		
57-000*	1 x D			.003 - .005		.003 - .005		.004 - .006		.006 - .008		.010 - .012					
61-000	1 x D			.001 - .003		.002 - .005		.002 - .005		.003 - .007		.007 - .009					
62-600	1 x D	.002 - .004		.002 - .004		.003 - .006		.003 - .006	.003 - .006	.004 - .008		.008 - .010					
63-000	1 x D			.006 - .008		.006 - .008		.007 - .009	.007 - .009	.008 - .010		.009 - .011					
63-600	1 x D	.002 - .004		.002 - .004		.003 - .006		.003 - .006	.003 - .006	.004 - .008		.008 - .010					
63-900	1 x D	.002 - .004		.002 - .004		.003 - .006		.003 - .006	.003 - .006	.004 - .008		.008 - .010					
64-000/ 65-000	1 x D	.002 - .004		.002 - .004		.003 - .006		.003 - .006		.004 - .008							
77-100(DE)				.002 - .004													
77-100(3E)								.003 - .005									
81-000	1 x D								.004 - .006	.004 - .006							
81-100	1 x D								.002 - .005	.003 - .008		.003 - .008					

* 16,000 RPM

** Aluminum Extrusion or Aluminum UAD Doors/Windows

NOTE: When cutting soft aluminum a squirt of cutting fluid every now and then will help to eliminate chip rewelding and improve surface finish

FORMULAS: Chip Load = Feed Rate / (RPM x # of cutting edges)
 Feed Rate (IPM) = RPM x # of cutting edges x chip load
 Speed (RPM) = Feed Rate / (# of cutting edges x chip load)

DEFINITIONS: IPM = Inches Per Minute
 IPR = Inches Per Revolution

Specialty Tool Chiploads

DEPTH OF CUT: 1 x D Use recommended chip load
 2 x D Reduce chip load by 25%
 3 x D Reduce chip load by 50%

CHIP LOAD PER TOOTH

Material: Foam

		Cutting Edge Diameter																					
Series	Cut	1/16	3/32	1/8	5/32	3/16	7/32	1/4	5/16	3/8	7/16	1/2	9/16	5/8	3/4	7/8	1	1 1/8	1 1/4	1 1/2	1 3/4	2	
12-00	1 x D			.0005 - .002		.0005 - .002		.001 - .003	.001 - .003	.002 - .004		.003 - .005		.004 - .006	.005 - .007		.006 - .008		.007 - .009				
40-550	1 x D											.004 - .006											
48-000	1 x D			.002 - .004		.002 - .004		.003 - .005	.003 - .005	.004 - .006		.005 - .007		.006 - .008	.007 - .009		.010						.010 - .012
52-550	1 x D			.002 - .004		.002 - .004		.004 - .006	.004 - .006	.004 - .006													
52-700	1 x D			.002 - .004		.002 - .004		.004 - .006	.004 - .006	.004 - .006		.005 - .007		.006 - .008	.007 - .009		.010						

Material: Wood

		Cutting Edge Diameter																					
Series	Cut	1/16	3/32	1/8	5/32	3/16	7/32	1/4	5/16	3/8	7/16	1/2	9/16	5/8	3/4	7/8	1	1 1/8	1 1/4	1 1/2	1 3/4	2	
37-00/ 37-20	Varies							.004-.006															
37-50	1/2 CED					.003 - .006		.003 - .006		.003 - .006													
37-60	1/2 CED									.004 - .006		.004 - .006			.006 - .008		.008 - .010						
37-80	Varies																.001 - .003		.001 - .003				.001 - .003

Material: Plastic

		Cutting Edge Diameter																					
Series	Cut	1/16	3/32	1/8	5/32	3/16	7/32	1/4	5/16	3/8	7/16	1/2	9/16	5/8	3/4	7/8	1	1 1/8	1 1/4	1 1/2	1 3/4	2	
37-00/ 37-20	Varies							.004-.006															
37-50*	1 x D					.003 - .006		.003 - .006		.003 - .006													
37-60*	1 x D									.004 - .006		.004 - .006			.006 - .008		.008 - .010						
37-80	Varies																.001 - .003		.001 - .003				.001 - .003
66-000	1 x D							.004 - .008		.004 - .008		.004 - .008											
66-200	1 x D							.004 - .006		.006 - .008													
66-300	1 x D			.002 - .004				.004 - .006		.006 - .008		.006 - .008											
66-350	1 x D			.002 - .004				.004 - .006		.006 - .008		.006 - .008											

Material: Aluminum

		Cutting Edge Diameter																					
Series	Cut	1/16	3/32	1/8	5/32	3/16	7/32	1/4	5/16	3/8	7/16	1/2	9/16	5/8	3/4	7/8	1	1 1/8	1 1/4	1 1/2	1 3/4	2	
37-00/ 37-20	Varies							.004-.006															
37-80	Varies																.001 - .003		.001 - .003				.001 - .003
66-200	1 x D							.004 - .006		.006 - .008													
66-300	1 x D			.002 - .004				.004 - .006		.006 - .008		.006 - .008											
66-350	1 x D			.002 - .004				.004 - .006		.006 - .008		.006 - .008											
77-025	1 x D	.002 - .004		.002 - .004		.003 - .006		.003 - .006															

FORMULAS: Chip Load = Feed Rate / (RPM x # of cutting edges)
 Feed Rate (IPM) = RPM x # of cutting edges x chip load
 Speed (RPM) = Feed Rate / (# of cutting edges x chip load)

DEFINITIONS: IPM = Inches Per Minute
 IPR = Inches Per Revolution



DEPTH OF CUT: 1 x D Use recommended chip load
 2 x D Reduce chip load by 25%
 3 x D Reduce chip load by 50%

CHIP LOAD PER TOOTH

		Cutting Edge Diameter															
Series	Cut	1/16	3/32	1/8	5/32	3/16	7/32	1/4	5/16	3/8	7/16	1/2	9/16	5/8	3/4	7/8	1
37-50	1xD					.003-.006		.003-.006		.003-.006							
37-60	1xD									.004-.006		.004-.006			.006-.008		.008-.010
52-000	1xD			.003-.006		.003-.006		.004-.006		.008-.010		.012-.014					
52-200B/BL	1xD	.002-.004		.002-.004		.002-.004		.004-.006		.004-.006		.006-.008		.008-.010	.010-.012		
52-400	1xD			.002-.004		.002-.004		.003-.005		.004-.006		.005-.007					
52-600	1xD							.004-.006		.006-.008		.008-.010		.008-.010	.010-.012		
56-000P	1xD			.002-.004		.002-.004		.004-.006		.006-.008		.008-.010					
56-450	1xD			.002-.004		.002-.004		.003-.005		.004-.006		.005-.007					
57-000	1xD			.002-.004		.002-.004		.003-.005		.004-.006		.005-.007					
57-200	1xD			.002-.004		.002-.004		.003-.005		.004-.006		.005-.007		.006-.008	.007-.009		
57-400	1xD			.002-.004		.002-.004		.003-.005		.004-.006		.005-.007		.006-.008	.007-.009		
57-600	1xD							.004-.006		.006-.008		.008-.010		.008-.010	.010-.012		
60-200	1xD							.002-.004		.002-.006				.004-.008			
62-700	1xD			.002-.004		.004-.006		.006-.010		.006-.010		.010-.012					
62-750	1xD			.002-.004		.004-.006		.006-.010		.006-.010		.010-.012					
62-800	1xD			.002-.004		.004-.006		.006-.010		.006-.010		.010-.012					
62-850	1xD			.002-.004		.004-.006		.006-.010		.006-.010		.010-.012					
63-700	1xD	.002-.003		.002-.004		.004-.006		.006-.010		.006-.010		.010-.012					
63-750	1xD	.002-.003		.002-.004		.004-.006		.006-.010		.006-.010		.010-.012					
63-800	1xD	.002-.003		.002-.004		.004-.006		.006-.010		.006-.010		.010-.012					
63-850	1xD	.002-.003		.002-.004		.004-.006		.006-.010		.006-.010		.010-.012					
64-000/ 65-000	1xD	.002-.004		.006-.008		.008-.010	.010-.012	.010-.012		.010-.012							
66-000	1xD							.002-.004		.003-.005		.004-.006					

FORMULAS: Chip Load = Feed Rate / (RPM x # of cutting edges)
 Feed Rate (IPM) = RPM x # of cutting edges x chip load
 Speed (RPM) = Feed Rate / (# of cutting edges x chip load)

DEFINITIONS:
 IPM = Inches Per Minute
 IPR = Inches Per Revolution

Drilling Cutting Data

		Drill Diameter															
Series		SFM	3	1/8	3/16	5	6	1/4	5/16	8	3/8	7/16	1/2	5/8	3/4	7/8	1
67-800	Composites	230		.001-.003	.001-.003			.002-.004	.002-.004		.003-.005	.003-.005	.003-.005				
68-900	Composites	230		0.001				0.0015			0.0015		0.0015				
70-500	Plastic	200		.019-.021				.021-.023			.023-.025		.025-.027	.027-.029	.029-.031	.031-.033	.033-.035
72-000*	Wood		.009-.011			.011-.013	.013-.015			.015-.017							
85-800	Composites	230		0.0005	0.0005			0.001	0.001		0.001	0.001	0.001				
86-100	Composites	165		0.001				0.0015			0.0015		0.0015				

* Gang drills run at 4,500 RPM and 150 IPM

FORMULAS: RPM = (3.82 x SFM) / tool dia.
 Feedrate (IPM) = RPM x IPR

DEFINITIONS:
 IPM = Inches Per Minute
 IPR = Inches Per Revolution

MODIFICATIONS MODIFICATION FORM

DISTRIBUTOR _____ DATE _____
 DISTRIBUTOR NUMBER _____ TOOL TO BE MODIFIED (PART NUMBER) _____
 DISTRIBUTOR PO NUMBER _____ QUANTITY _____
 SALES ORDER NUMBER _____
 FORM COMPLETED BY _____

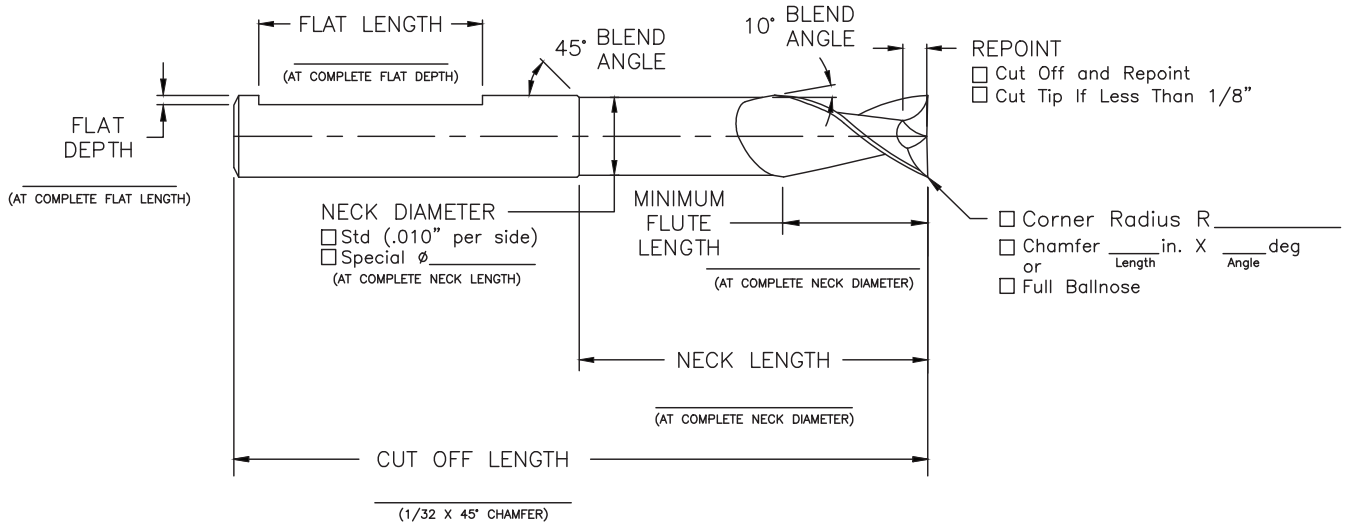

NOTES: _____

Tool Modification Instructions

- Complete form
- Fax to Onsrud with purchase order number.
- Orders must be received before 2:30 PM (Central time) in order to ship the following day.
- You will receive a confirmation fax
- Any modifications over 5 pieces will be treated as a special tool.

TOOL MODIFICATION

Part Number	Description
BALLNOSE	RADIUS: _____
RADIUS	DIAMETER: _____
CHAMFER	CUT OFF AND CHAMFER
CUT-REPOINT	CUT OFF TIP AND REPOINT
CUT-TIP	CUT OFF TIP UNDER 1/8
*ERL/SPNBCK	CEL RQD: _____ DIA: _____
FLAT	FLATS ON SHANK
REPOINT-1/8	REPOINT LESS THAN 1/8"

CUTTING TOOL QUOTE REQUEST FORM

1081 S. Northpoint Blvd. • Waukegan, Illinois 60085 • Phone (847) 362-1560 • Fax (800) 557-6720 • www.onsrud.com

*Starred Items = Required information

*Distributor Name _____ *Distributor's Reference Number _____

*Distributor Address _____

*Contact _____ *Email Address _____

*Telephone _____ *Fax _____

End User Name _____ Customer Reference Number _____

End User Address _____

Contact _____ Email Address _____

Telephone _____ Fax _____

*Material being machined _____ Hardness _____

Machine type (Check all that apply): CNC Router CNC Mill Inverted Air Router Hand Other

If other, describe _____

H.P.= _____

Max. Spindle Speed _____ Coolant Type _____

*Tool Material: HSS Solid Carbide Carbide Tip Powder Metal PCD Full Face PCD Tip Other

If other, describe _____

*Flute Style: Spiral Up Spiral "O" Up Straight "V" Flute Compression
 Spiral Down Spiral "O" Down Straight "O" Flute Morise Compression

*Flute Form: Rougher Chipbrk/Finisher Finisher Other

*Point Geometry: Square Ball Nose Drill Point Other
 Center Cutting Non-Center Cutting

*If other, describe _____

*Tool Similar To: _____

Cutting Diameter (CED) _____

Cutting Length (CEL) _____

Shank Diameter (SHK) _____

Overall Length (OAL) _____

Neck Diameter (ND) _____

Neck Radius (NL) _____

Corner Radius (CR) _____

Coolant Through Yes No

Transition Grind Needed _____

Flat Y / N What Type? _____

Coating Types: TiN TiCN AlTiN Diamond Grit ZrN TiAlN DFC Diamond "Like" Other

If other, describe _____

*Quantities Needed: _____

Minimum is 6 pieces

Any Target Pricing? _____

Distributor / End User? _____

Additional Notes: _____

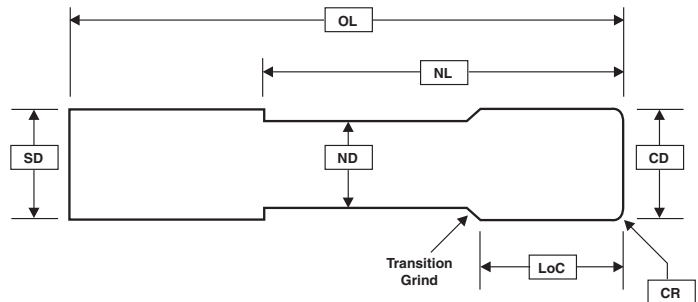

Cutting Tool Design

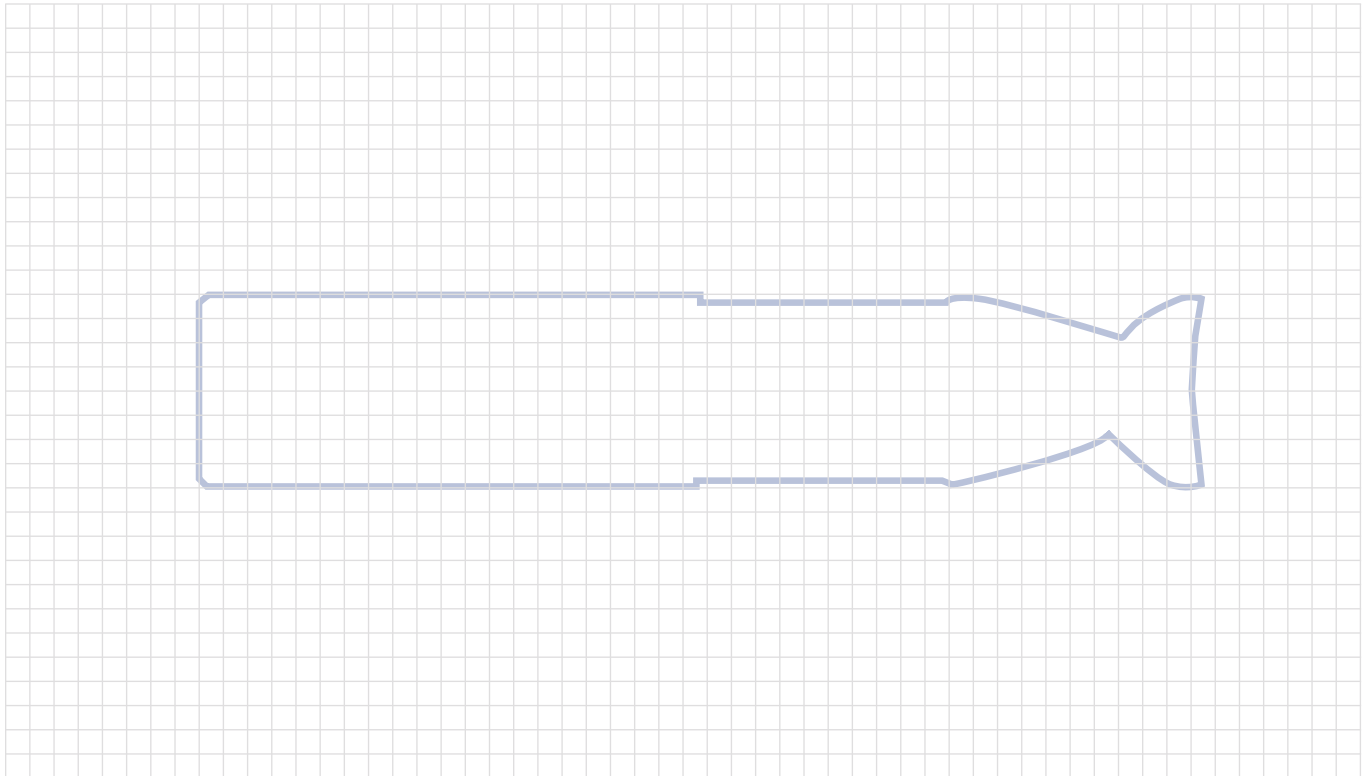
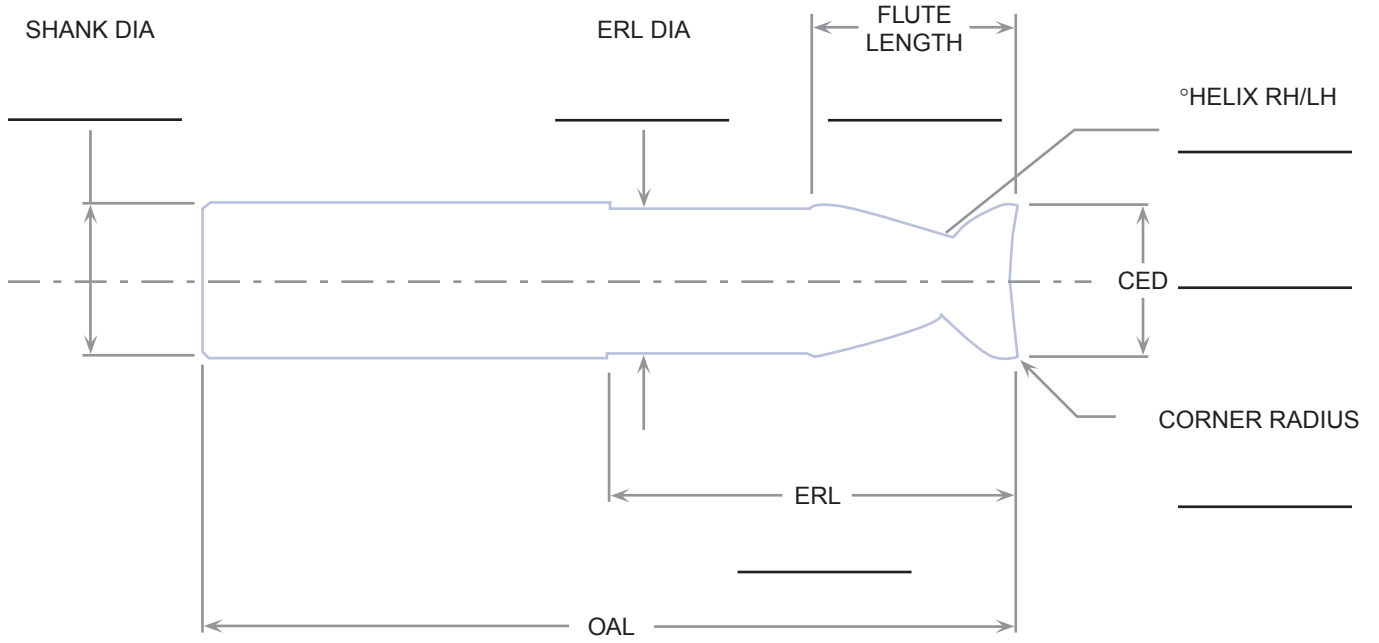

LMT Onsrud Terms & Conditions

Shipping - F.O.B. Waukegan, IL. All shipments ground unless otherwise specified.

Claims – Any claims for shortage, damage or loss must be made within 30 days of invoice date. United Parcel Service is a preferred method of shipment because of reliability and ease of tracing problem shipments.

Guarantee - Our products are guaranteed against defects in material and quality of manufacture when used in the proper manner. If tools are returned and found to be defective, we will repair or replace the tools. Continued tool breakage caused by improper tool usage without the knowledge of LMT Onsrud's technical staff is not a condition for return and replacement of such tools.

Errors - LMT Onsrud, LP cannot be held responsible for incorrect parts made with our products due to mislabeling or defect.

Return Goods Policy – No merchandise can be returned without prior authorization. Credit will not be issued for merchandise returned without a return authorization number. Product must be a current revision catalog item in new and saleable condition. All returns subject to a 15% restocking fee or offsetting order of equal value.

Specials - LMT Onsrud, LP has the right to over or under ship by 10% all specials. Special orders less than 10 pieces are subject to +/- 1 piece. Specials and modified tools are not returnable for credit. Specials cancelled will be assessed an in-process charge based on the status of the order and expenses incurred at the time of cancellation. If a special tool has been completed, the tool will be shipped and the price quoted will be billed.

Safety Precautions – Cutting tools should only be used to perform operations that are compatible with the original tool design. Safety glasses and other appropriate safety equipment should be worn by all people in the vicinity of tool use.

Prices & Terms - All prices and terms are subject to change without notice. All orders are subject to acceptance at LMT Onsrud.



LMT Onsrud LP
1081 S. Northpoint Blvd.
Waukegan, IL 60085
TOLL FREE +1 800 234 1560

www.onsrud.com

ISO 9001 Certified

Distributed By: